

Panasonic®



2.4 GHz Digital Cordless Answering System

Operating Instructions

Model No. **KX-TG2386**

Pulse-or-tone dialing capability

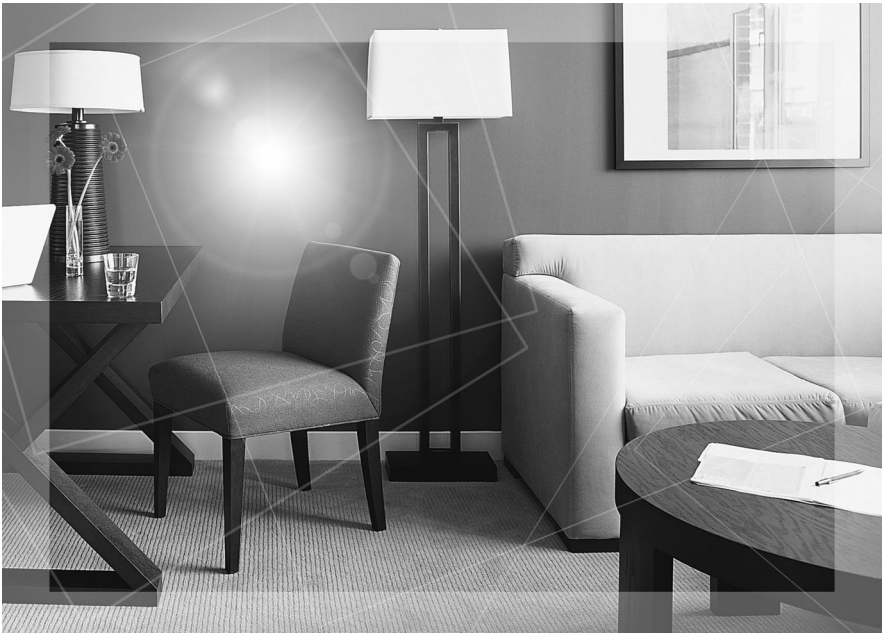

The unit is Caller ID compatible. To display the caller's name and phone number, you must subscribe to Caller ID service.

PLEASE READ BEFORE USE AND SAVE.

Charge the battery for 6 hours before initial use.

Panasonic World Wide Web address: <http://www.panasonic.com>
for customers in the USA or Puerto Rico

Thank you for purchasing your new Panasonic cordless telephone.

Please read the IMPORTANT SAFETY INSTRUCTIONS on page 83 before use. Read and understand all instructions.

Caller ID and Call Waiting Service, where available, are telephone company services. After subscribing to Caller ID this phone will display a caller's name and phone number. Call Waiting Caller ID, which displays a second caller's name and phone number while the user is on another call, requires a subscription to both Caller ID and Call Waiting with Caller ID Services (CWID).

Attach your purchase receipt here.

Copyright:

This material is copyrighted by Panasonic Communications Co., Ltd., and may be reproduced for internal use only. All other reproduction, in whole or in part, is prohibited without the written consent of Panasonic Communications Co., Ltd.

© 2004 Panasonic Communications Co., Ltd. All Rights Reserved.

Accessories (included)

For extra orders, call 1-800-332-5368.

For hearing or speech impaired TTY users, call 1-866-605-1277.

- AC Adaptor (p. 9)
Order No. PQLV1Z (PQLV1)

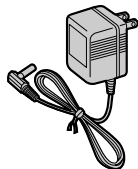

one

- Telephone Line Cord (p. 9)
Order No. PQJA10075Z



one

- Battery (p. 10)
Order No. HHR-P104

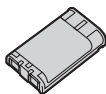

one

- Handset Cover (p. 10)
Order No. PQYNTG2386BR

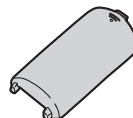

one

- Belt Clip (p. 72)
Order No. PQKE10375Z2



one

- Shoulder Rest Attachment (p. 72)
Order No. PQKE10364Z1



one

For Best Performance

Battery Charge

The handset is powered by a rechargeable Nickel-Metal Hydride (Ni-MH) battery. Charge the battery for **6 hours** before initial use (p. 10).

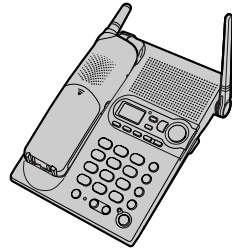

Base Unit Location/Noise

Calls are transmitted between the base unit and handset using wireless radio waves. **For maximum distance and noise-free operation**, the recommended base unit location is:

Away from electrical appliances such as a TV, personal computer or another cordless phone.

In a **HIGH and CENTRAL** location with no obstructions such as walls.

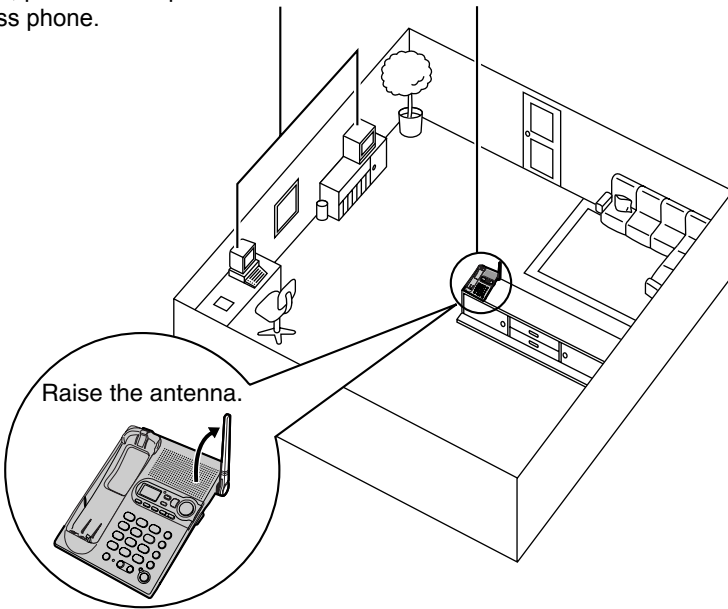

Note:

- If you use the handset near a microwave oven which is being used, noise may be heard from the receiver or the speaker. Move away from the microwave oven and closer to the base unit.
- If you use the handset near another cordless phone's base unit, noise may be heard. Move away from the other cordless phone's base unit and closer to your base unit.

Contents

Preparation

Location of Controls	6
Installation	9
Connections	9
Installing the Battery in the Handset	10
Battery Charge	10
Programmable Settings	12
Programming Guidelines ..	12
Function Menu Table	13
Date and Time	14
Display Language	15
Dialing Mode	15
Line Mode	16
Auto Talk	16
Ringer Volume	17
Ringer Tone	18
LCD Contrast	20
Talking Keypad	20
Name Announcement	22
Hearing Aid Mode	23
Preparing the Answering System	23
Greeting Message	23
Caller's Recording Time ..	26
Number of Rings	26
Recording Mode	27
Message Alert	28

Telephone System

Making Calls	29
Using the Handset	29
Using the Base Unit	32
Answering Calls	34
Caller ID Service	35
Talking Caller ID	36
Using the Caller List	37
Viewing the Caller List ..	38
Calling Back from the Caller List	39

Editing the Caller's Phone Number	40
Caller ID Number Auto Edit	41
Storing Caller Information in the Phone Book	42
Erasing Caller Information ..	43
Phone Book	44
Storing Names and Numbers	44
Dialing from the Phone Book	46
Chain Dial	48
Editing an Item in the Phone Book	49
Erasing an Item in the Phone Book	49
One-Touch Dialer	50
Storing an Item in the Phone Book to the One-Touch Dialer	50
Dialing a Stored Number ..	51
Erasing	52
Locator/Intercom	52
Making Intercom Calls	52
Answering Intercom Calls ..	53
Transferring a Call	54
Conference Calls	56
Call Share	56
Special Features	57
Temporary Tone Dialing (For Rotary or Pulse Service Users)	57
Muting Your Conversation For Call Waiting Service Users	57
Using the PAUSE Key (For PBX Line/Long Distance Calls)	58
FLASH Button	58
Incoming Call Tone	59
Key Tone	60

Re-registering the Handset	60
----------------------------------	----

Answering System

Automatic Answering

Operation	61
Setting the Unit to Answer Calls	61
Monitoring Incoming Calls ..	62

Listening to Messages

Listening to Messages	63
Using the Base Unit	63
Using the Handset (Remote Operation)	64

Erasing Messages

Erasing Messages	66
Recording a Memo Message	67

Remote Operation from a Touch

Tone Phone	67
Remote Code	68
Voice Menu	69
Direct Remote Operation ..	70

Useful Information

Wall Mounting	71
Belt Clip	72
Shoulder Rest Attachment ..	72
Optional Headset	73
Direct Commands	74
If the Following Appear on Your Display...	76
Troubleshooting	77
Important Safety Instructions	83
FCC and Other Information ..	84
Index	87
Warranty	89
Specifications	91

Important:

Throughout these Operating Instructions, **Handset** and **Base Unit** are used to indicate with which unit an operation can be performed.

Handset : Perform with the handset.

Base Unit : Perform with the base unit.

Handset Base Unit : Perform with the handset and base unit separately.

Handset & Base Unit : Perform with the handset and base unit together.

Location of Controls

Base unit

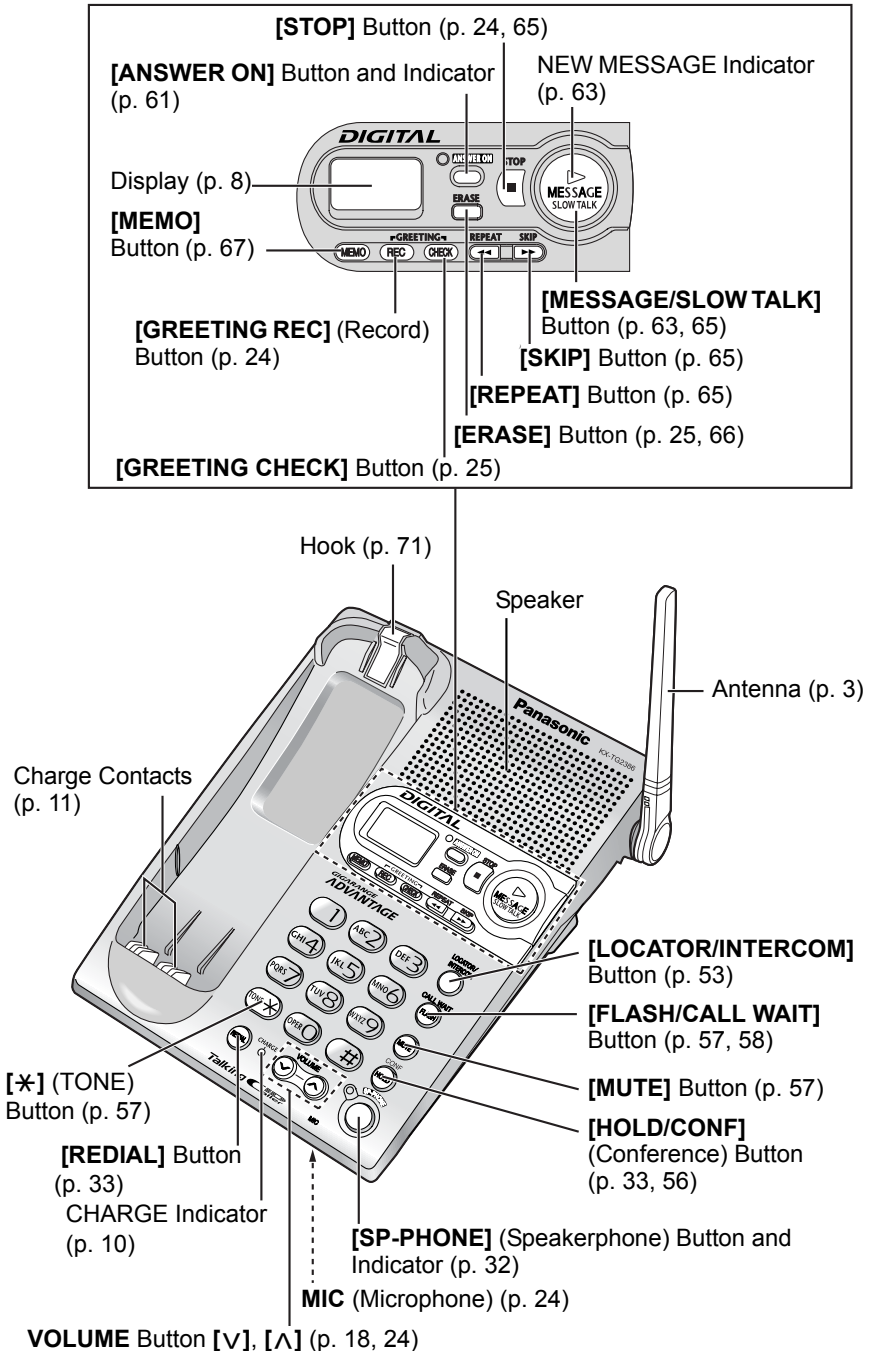

Handset

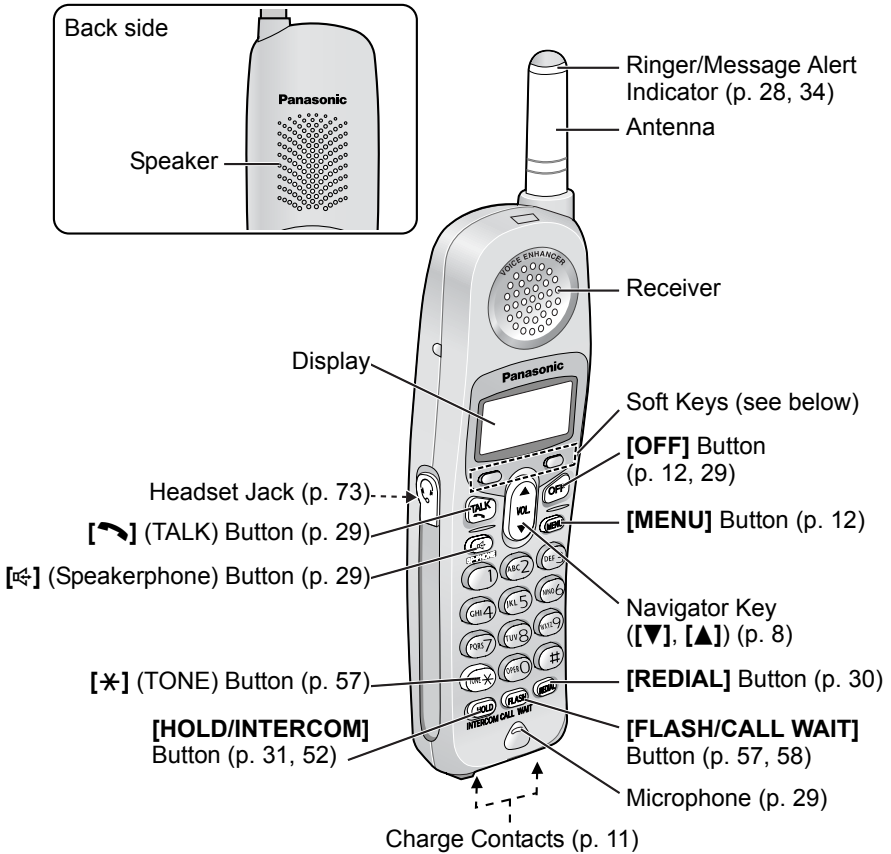

Handset soft keys

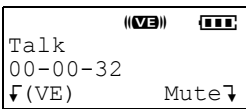

Two soft keys are used to select functions displayed directly above each key. Functions displayed above the keys will change depending on the state of use.

On this sample display, “**VE**” and “**Mute**” are displayed above soft keys.



Pressing the right soft key selects mute “**Mute**”.

Pressing the left soft key selects Voice Enhancer “**VE**”.

- When a function name does not appear above a soft key, the soft key has no function.

Location of Controls

Handset navigator key



Scrolls up [▲] and down [▼] the function menu, the Caller List and the phone book.

Increases [▲] or decreases [▼] the handset ringer and receiver/speaker volumes.

Throughout these Operating Instructions, the navigator key is indicated by the arrows [▼] or [▲].

Base unit display

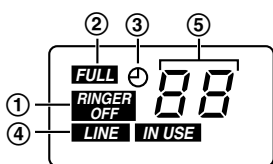

① “**RINGER OFF**” indicates the base unit ringer is off (p. 18).

② “**FULL**” flashes when no new messages can be recorded. Erase unnecessary messages (p. 66).

③ “⊕” flashes until you set the date and time, and flashes after a power failure. If it is flashing, set the date and time (p. 14).

④ “**LINE IN USE**” functions as follows.

Off (invisible)	The line is free.
On	The line is being used.
Flashing	A call is on hold on the handset or base unit or the Answering System is answering a call (p. 61).
Flashing rapidly	A call is being received.

• “**IN USE**” is displayed when a handset user is operating the Answering System, or when the Talking Keypad (p. 20, 21) or Name Announcement feature (p. 22) is announcing a name or phone number.

⑤ Message counter shows:

- the total number of recorded messages. If the recording time is set to “Greeting only”, “**99**” will be displayed (p. 26).
- the selected volume level while you are adjusting the volume (p. 24, 33).
- “**E**” when your greeting message or memo message was not recorded correctly (p. 24, 67).

Installation

Connections

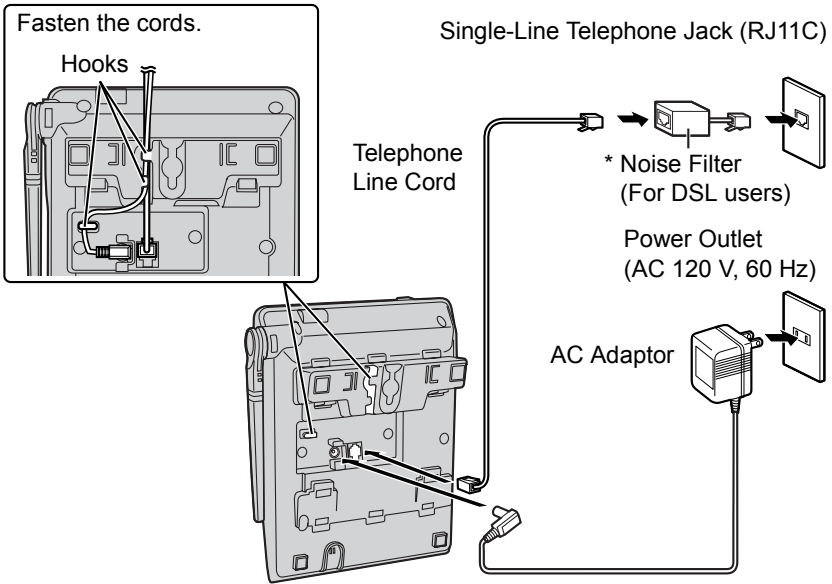

- USE ONLY WITH Panasonic AC ADAPTOR PQLV1 (Order No. PQLV1Z).
- The AC adaptor must remain connected at all times. (It is normal for the adaptor to feel warm during use.)
- The AC adaptor should be connected to a vertically oriented or floor-mounted AC outlet. Do not connect the AC adaptor to a ceiling-mounted AC outlet, as the weight of the adaptor may cause it to become disconnected.
- If your unit is connected to a PBX which does not support Caller ID, you cannot access Caller ID services.
- The unit will not work during a power failure. We recommend connecting a standard telephone to the same telephone line or to the same telephone jack using the Panasonic KX-J66 T-adaptor.
- * If the unit is connected to a telephone line with DSL service, you may hear noise from the receiver or speaker during conversations or the unit may not display caller's name and/or phone number properly. We recommend connecting a noise filter (contact your DSL service provider) to the telephone line between the base unit and the telephone line jack.

Installation

Installing the Battery in the Handset

Insert the battery (①), and press it down until it snaps into the compartment (②). Close the cover.

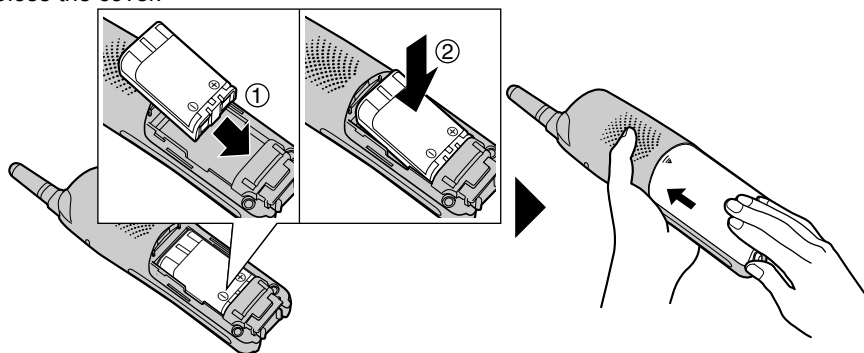

To replace the battery:

Press the notch on the cover firmly and slide it as indicated by the arrow. Replace the old battery with a new one (p. 11). Close the cover and charge the battery for 6 hours.

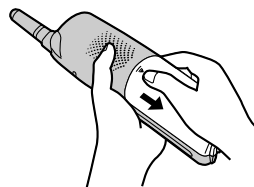

Battery Charge

Place the handset on the base unit. Charge for **6 hours** before initial use.

- The unit beeps once, the CHARGE indicator lights, and “Charging” is displayed.
- When the battery is fully charged, “Charge completed” is displayed.

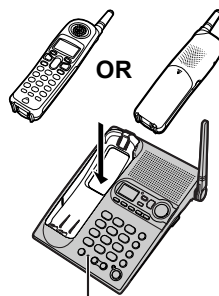

CHARGE Indicator

Battery strength

You can confirm battery strength on the handset display. Battery strength is indicated by the icons shown in the chart to the right.



Display prompt	Battery strength
	Fully charged
	Medium
	Low
(flashing)	Needs to be recharged.
	Discharged

Recharge

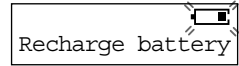

Recharge the battery when:

- “**Recharge battery**” is displayed on the handset,
- “” flashes, or
- the handset beeps intermittently while it is in use.



- The display will continually indicate “**Recharge battery**” and/or “” will flash when the handset battery is charged for less than 15 minutes and the handset is lifted off the base unit.
- If the battery has been discharged, the handset will display “**Charge for 6h**” and “” when you place the handset on the base unit. The handset will not work unless the battery is charged. Continue charging.

Battery replacement:

If you cleaned the charge contacts and fully charged the battery, but after a few telephone calls, “**Recharge battery**” is displayed and/or “” continues to flash, or “**Charge for 6h**” and “” are displayed, the battery may need to be replaced. Please order a new Panasonic HHR-P104 battery at the telephone number shown on page 2. To replace the battery, see page 10.

A nickel metal hydride battery that is recyclable powers the product you have purchased. Please call 1-800-8-BATTERY for information on how to recycle this battery.



Battery information

After your Panasonic battery is fully charged, you can expect the following performance:

Operation	Operating time
While in use (TALK)	Up to 5 hours
While not in use (Standby)	Up to 11 days
While in use (TALK) when the Hearing Aid mode is Telecoil (p. 23)	Up to 2 hours

- A fully charged battery will give you up to 5 hours of continuous talk time, or keep your handset in Standby mode to receive incoming calls for up to 11 days (if no phone calls are made). Battery power is consumed whenever the handset is off of the base unit, even when the handset is not in use. The longer you leave the handset off of the base unit, the time you can actually talk on the handset will be shortened. Actual battery performance depends on a combination of how often the handset is in TALK mode and how often it is in Standby mode.
- **Clean the charge contacts of the handset and the base unit with a soft, dry cloth once a month. Clean more often if the unit is subject to grease, dust or high humidity.** Otherwise the battery may not charge properly.
- If the battery is fully charged, you do not have to place the handset on the base unit until “**Recharge battery**” is displayed and/or “” flashes. This will maximize the battery life.
- If you want to keep the battery fully charged at all times, place the handset on the base unit when the handset is not used. The battery cannot be overcharged.

Programmable Settings

Programming Guidelines **Handset**

This unit has several programmable functions which can be selected from the function menu on the display (p. 13).

The **soft keys** selects the functions displayed above each soft key.

When “▼” or “▲” is displayed, navigator key scrolls through the menu.

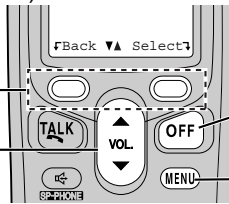

[OFF] exits programming.

[MENU] enters the function menu.

How to select a function item from the menu

Make sure the handset and the base unit are not being used. The handset must be operated near the base unit and while off the base unit.

1 Press **[MENU]**.

- The main menu is displayed (p. 13).

2 Scroll to the desired item by pressing **[▼]** or **[▲]**.



3 Press the soft key (**Select**) to select the desired item.



4 If the item has a sub-menu, select the menu item (p. 13). Repeat steps 2 and 3 until the desired item is displayed. If the item has no sub-menu, go to step 5.

5 Select the desired setting by pressing **[▼]** or **[▲]**, then press the soft key (**Save**) to save your setting.

- A confirmation tone will be heard and the setting will be saved.



6 Press **[OFF]** to exit programming mode.

- To go back to the previous menu, press the soft key (**Back**), or press the soft key (**Select**) while “--- (Go back) ---” is displayed. If you press this key in the main menu, the unit will exit programming mode.
- After programming is complete, the display will return to the main menu or the sub-menu depending on which menu the selected item is located. (See the menu table on page 13.)
- You can exit programming mode at any time by pressing **[OFF]**.
- If you do not press any buttons for 60 seconds, the handset will exit programming mode.
- If the unit detects a problem, an error message will be displayed (p. 76) and/or error beeps will sound.

Function Menu Table **Handset**

You can use the following functions to customize your unit. See the corresponding pages for function details.

- After pressing **[MENU]**, you can also program menu items directly by pressing **[0]** to **[9]**, **[*]** and **[#]** instead of using the soft keys (p. 74–75).

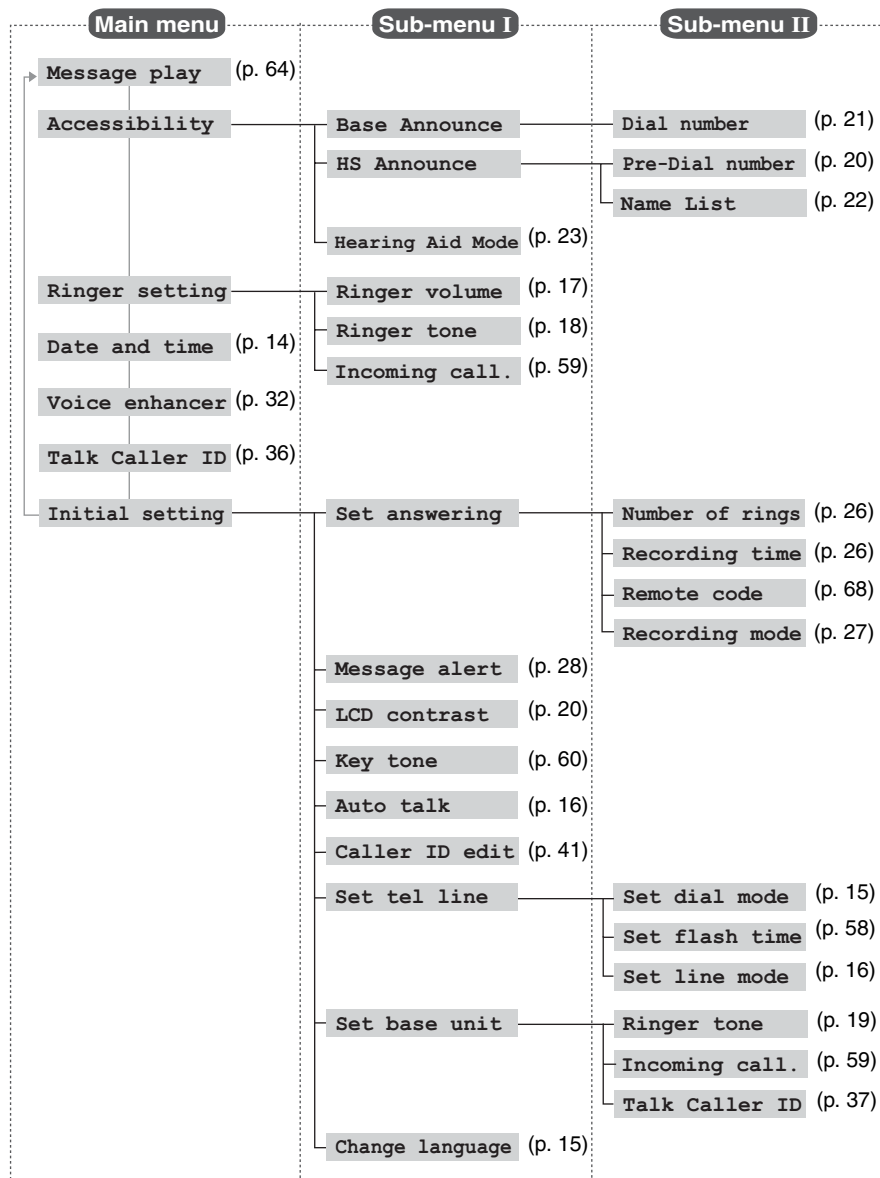

Programmable Settings

Date and Time **Handset**

We recommend you set the date and time so that the unit will announce the day and time each message was recorded when you play back messages.

1 Press **[MENU]**.

2 Scroll to “Date and time” by pressing **[▼]** or **[▲]**, then press the soft key (**Select**).

Date and time
↓Back ▲ Select↓

3 ① Enter 2 digits each for the month, day, and year. (Ex. To set May 15, 2004, enter “05 15 04”.)

Date:12.31.2004
Time:12:00 AM
↓AM/PM Save↓

② Enter 4 digits for the time (hour and minute).
(Ex. To set 9:30, enter “0930”.)

Example
Date:05.15.2004
Time:09:30 AM
↓AM/PM Save↓

• If you enter a wrong number, press **[▼]** or **[▲]** to move the cursor to the incorrect number. Enter the correct number.

4 Select “**AM**” or “**PM**” by pressing the soft key (**AM/PM**).

Date:05.15.2004
Time:09:30 AM
↓AM/PM Save↓

5 Press the soft key (**Save**).

- The date and time are set and “Ⓞ” disappears from the base unit display.
- If the handset beeps 3 times, the date and time were not set correctly. Start again from step 3.

6 Press **[OFF]**.

- When entering the time in step 3, you cannot enter numbers greater than 12. **Do not use military time.** (To set 13:00 hours, enter “0100”, then select “**PM**” in step 4.)

The date and time may be incorrect after a power failure. When “Ⓞ” flashes on the base unit display, set the date and time again.

To confirm the date and time, repeat steps 1 and 2 above.

- The current date and time are displayed. When finished, press **[OFF]**.

For Caller ID service users (p. 35)

- When a call is received, Caller ID information adjust the date and time if the time is incorrect.
- Caller ID information will automatically adjust the date and time for daylight saving time.
- If the date and time has not previously been set, Caller ID information will not adjust the date and time.

Display Language **Handset**

You can select either “English” or “Spanish” as the display language. The factory preset is “English”.

1 Press **[MENU]**.

2 Scroll to “**Initial setting**” by pressing **[▼]** or **[▲]**, then press the soft key (**Select**).

```
Initial setting
└Back ▼▲ Select┘
```

3 Scroll to “**Change language**” by pressing **[▼]** or **[▲]**, then press the soft key (**Select**).

```
Change language
└Back ▼▲ Select┘
```

4 To change from English to Spanish, press the soft key (**Español**).

To change from Spanish to English, press the soft key (**English**).

- The display changes to the selected language.
- You can also select a language by pressing **[▼]** or **[▲]**.

```
Display
:English
└Español Save┘
```

5 When Spanish is selected, press the soft key (**Salvar**), then press **[OFF]**.

When English is selected, press the soft key (**Save**), then press **[OFF]**.

- If you select a language you cannot read, change the display language again using direct commands (p. 75).

Dialing Mode **Handset**

If you have touch tone service, set the dialing mode to “Tone”. For rotary or pulse service, set to “Pulse”. The factory preset is “Tone”.

1 Press **[MENU]**.

2 Scroll to “**Initial setting**” by pressing **[▼]** or **[▲]**, then press the soft key (**Select**).

```
Initial setting
└Back ▼▲ Select┘
```

3 Scroll to “**Set tel line**” by pressing **[▼]** or **[▲]**, then press the soft key (**Select**).

```
Set tel line
└Back ▼▲ Select┘
```

4 Press the soft key (**Select**) at “**Set dial mode**”.

```
Set dial mode
└Back ▼▲ Select┘
```

5 Select “**Pulse**” or “**Tone**” by pressing **[▼]** or **[▲]**.

```
Set dial mode
:Tone
└Back ▼▲ Save┘
```

6 Press the soft key (**Save**), then press **[OFF]**.

Programmable Settings

Line Mode **Handset**

The line mode is preset to “B” and generally should not be adjusted. If “Line in use” on the handset and “**LINE IN USE**” on the base unit are not displayed properly, the line mode selection is incorrect. Set line mode to “A”.

1 Press **[MENU]**.

2 Scroll to “Initial setting” by pressing **[▼]** or **[▲]**, then press the soft key (**Select**).

```
Initial setting
┆Back ▼▲ Select┆
```

3 Scroll to “Set tel line” by pressing **[▼]** or **[▲]**, then press the soft key (**Select**).

```
Set tel line
┆Back ▼▲ Select┆
```

4 Scroll to “Set line mode” by pressing **[▼]** or **[▲]**, then press the soft key (**Select**).

```
Set line mode
┆Back ▼▲ Select┆
```

5 Select “A” or “B” by pressing **[▼]** or **[▲]**.

```
Set line mode
: B
┆Back ▼▲ Save┆
```

6 Press the soft key (**Save**), then press **[OFF]**.

Auto Talk **Handset**

The Auto Talk feature allows you to answer calls by simply lifting the handset off the base unit. You do not need to press **[📞]** or **[📞]**. The factory preset is OFF.

1 Press **[MENU]**.

2 Scroll to “Initial setting” by pressing **[▼]** or **[▲]**, then press the soft key (**Select**).

```
Initial setting
┆Back ▼▲ Select┆
```

3 Scroll to “Auto talk” by pressing **[▼]** or **[▲]**, then press the soft key (**Select**).

```
Auto talk
┆Back ▼▲ Select┆
```

4 Select “on” or “off” by pressing **[▼]** or **[▲]**.

```
Auto talk
: Off
┆Back ▼▲ Save┆
```

5 Press the soft key (**Save**), then press **[OFF]**.

- In order to view Caller ID information after you lift the handset to answer a call, leave the Auto Talk feature turned off.

Ringer Volume

You can select the handset or base unit ringer volumes to high, medium, low, or off. The factory preset is HIGH. If the handset and base unit ringer is turned off, the handset or base unit will ring at the low level for intercom calls, and will not ring for outside calls. Caller name will not be announced even if the Talking Caller ID feature is on (p. 36, 37).

Handset ringer volume **Handset**

1 Press **[MENU]**.

2 Scroll to “**Ringer setting**” by pressing **[▼]** or **[▲]**, then press the soft key (**Select**).

```
Ringer setting
└Back ▼▲ Select┘
```

3 Press the soft key (**Select**) at “**Ringer volume**”.

```
Ringer volume
└Back ▼▲ Select┘
```

4 Select the desired volume level by pressing **[▼]** or **[▲]**.

- The volume will change and ring.
- The number of steps indicates the volume level.
- **To turn the ringer off**, press **[▼]** repeatedly until “**off ?**” is displayed.

```
Ex. High
Ringer volume
Low ■■■■■ High
└Back ▼▲ Save┘
```

5 Press the soft key (**Save**).

- If the handset ringer is turned off, “**Ringer off**” will be displayed while not in use. If the handset is off the base unit when there are missed calls (p. 37) or new messages (p. 64), “**Ringer off**” is not displayed.
- You can adjust the ringer volume while an outside call is ringing. Press **[▼]** or **[▲]** while the handset is ringing.

Temporary ringer off

While the handset is ringing for an outside call, you can turn the ringer off temporarily by pressing **[OFF]**. The handset will ring again as normal the next time a call is received.

Programmable Settings

Base unit ringer volume **Base Unit**

Make sure the base unit is not being used.

To set the ringer volume to high (preset), medium, or low, press **VOLUME [V]** or **[^]**.

- To increase volume, press **VOLUME [^]**. To decrease volume, press **VOLUME [V]**.
- To stop ringing, press **[STOP]**.

To turn the ringer off, press and hold **VOLUME [V]** until 2 beeps sound.

- “**RINGER OFF**” is displayed.

To turn the ringer on, press **VOLUME [V]** or **[^]**.

- The base unit will ring at low level.
- You can adjust the ringer volume while an outside call is ringing. Press **VOLUME [V]** or **[^]** while the base unit is ringing.

To turn the ringer off, press and hold **VOLUME [V]** for 2 beeps sound.

- “**RINGER OFF**” is displayed.

Ringer Tone

You can select the handset and base unit ringers to use one of 7 ringer patterns for outside calls. “Tone 1” to “Tone 3” are bell ringer patterns. “Melody 1” to “Melody 4” are melody patterns. The factory preset is “Tone 1”.

- You cannot change the ringer tone for intercom calls.
- If you subscribe to a Distinctive Ring Service (such as IDENTA-RING) from your telephone company with 2 or 3 consecutive rings, select a bell ringer pattern (Tone 1 to 3). If you select a melody pattern, you will not be able to distinguish lines by their ringers.
- If you select one of the melody ringer patterns, the ringer will continue to sound for several seconds if:
 - the caller hangs up before you answer the call, or
 - another person answers the call using another phone connected on the same line.

Handset ringer tone **Handset**

1 Press **[MENU]**.

2 Scroll to “**Ringer setting**” by pressing **[▼]** or **[▲]**, then press the soft key (**Select**).

Ringer setting
⌵Back ▼▲ Select⌵

3 Scroll to “**Ringer tone**” by pressing **[▼]** or **[▲]**, then press the soft key (**Select**).

Ringer tone
⌵Back ▼▲ Select⌵

- 4 Select the desired ringer tone by pressing [▼] or [▲].

- The handset will ring and the ringer tone will change. If the handset ringer volume has been turned off, the handset will not ring (p. 17).
- You can also select the ringer tone by pressing [1] to [7].

```
Ringer tone
1:Tone 1
↓Back  ▼▲ Save↓
```

- 5 Press the soft key (save), then press [OFF].

Base unit ringer tone (use either the handset or the base unit)

Base Unit

Make sure the base unit is not being used.

Press **VOLUME** [V] or [^], then select the desired ringer tone by pressing [1] to [7].

[1] to [3] : Bell ringer patterns [4] to [7] : Melody patterns

- After pressing **VOLUME** [V] or [^], the base unit will ring using the current ringer tone.
- The base unit will ring and the ringer tone will change.
- To stop ringing, press [STOP].

Setting the base unit ringer tone by using the Handset

- 1 Press [MENU].

- 2 Scroll to “Initial setting” by pressing [▼] or [▲], then press the soft key (Select).

- 3 Scroll to “Set base unit” by pressing [▼] or [▲], then press the soft key (Select).

- 4 Press the soft key (Select) at “Ringer tone”.

- 5 Select the desired ringer tone by pressing [▼] or [▲].

- The base unit will ring and the ringer tone will change. If the base unit ringer volume has been turned off, the base unit will not ring (p. 18).
- You can also select the ringer tone by pressing [1] to [7].

- 6 Press the soft key (save), then press [OFF].

Programmable Settings

LCD Contrast **Handset**

There are 6 levels of LCD contrast. The factory preset is "level 3".

1 Press **[MENU]**.

2 Scroll to "Initial setting" by pressing **[▼]** or **[▲]**, then press the soft key (**Select**).

Initial setting
┆Back ▼▲ Select┆

3 Scroll to "LCD contrast" by pressing **[▼]** or **[▲]**, then press the soft key (**Select**).

LCD contrast
┆Back ▼▲ Select┆

4 Select the desired contrast by pressing **[▼]** or **[▲]**.

- The contrast will change.

Ex. Level 3
LCD contrast
Low ■■■ High
┆Back ▼▲ Save┆

5 Press the soft key (**Save**), then press **[OFF]**.

Talking Keypad **Handset** **Base Unit**

Talking Keypad is a feature that announces phone numbers that you dial, allowing you to confirm dialed numbers audibly before making calls. You can turn this feature on or off for the handset and base unit separately. The factory preset is ON. While handset Talking Keypad is turned on, the handset announces each dialing button you press when pre-dialing (p. 30).

While base unit Talking Keypad is turned on, the base unit announces each dialing button you press, and announces "Redial" when **[REDIAL]** is pressed (p. 32, 33).

If you dial a phone number quickly, the handset and base unit may not announce the dialed phone number correctly. For best results, dial each digit one at a time, and wait for the unit to announce each digit before dialing the next digit.

Handset Talking Keypad feature **Handset**

1 Press **[MENU]**.

2 Scroll to "Accessibility" by pressing **[▼]** or **[▲]**, then press the soft key (**Select**).

Accessibility
┆Back ▼▲ Select┆

3 Scroll to "HS Announce" by pressing **[▼]** or **[▲]**, then press the soft key (**Select**).

HS Announce
┆Back ▼▲ Select┆

Programmable Settings

4 Press the soft key (**Select**) at “Pre-Dial number”.

Pre-Dial number
┆Back ▼▲ Select┆

5 Select “off” or “on” by pressing [▼] or [▲].

Pre-Dial number
:On
┆Back ▼▲ Save┆

6 Press the soft key (**save**), then press [OFF].

Base Unit Talking Keypad feature **Handset**

1 Press [MENU].

2 Scroll to “Accessibility” by pressing [▼] or [▲], then press the soft key (**Select**).

Accessibility
┆Back ▼▲ Select┆

3 Press the soft key (**Select**) at “Base Announce”.

Base Announce
┆Back ▼▲ Select┆

4 Press the soft key (**Select**) at “Dial number”.

Dial number
┆Back ▼▲ Select┆

5 Select “off” or “on” by pressing [▼] or [▲].

Dial number
:On
┆Back ▼▲ Save┆

6 Press the soft key (**save**), then press [OFF].

Programmable Settings

Name Announcement **Handset**

Name Announcement is a feature that announces names or phone numbers shown on the display while you are using the handset to search the phone book, caller list, redial list, and one-touch dialer, allowing you to confirm displayed items audibly before making calls.

You can turn this feature on or off for the handset. The factory preset is ON.

1 Press **[MENU]**.

2 Scroll to “**Accessibility**” by pressing **[▼]** or **[▲]**, then press the soft key (**Select**).



Accessibility
↓Back ▼▲ Select↓

3 Scroll to “**HS Announce**” by pressing **[▼]** or **[▲]**, then press the soft key (**Select**).



HS Announce
↓Back ▼▲ Select↓

4 Scroll to “**Name List**” by pressing **[▼]** or **[▲]**, then press the soft key (**Select**).



Name List
↓Back ▼▲ Select↓

5 Select “**off**” or “**on**” by pressing **[▼]** or **[▲]**.



Name List
:On
↓Back ▼▲ Save↓

6 Press the soft key (**Save**), then press **[OFF]**.

Hearing Aid Mode **Handset**

Hearing Aid Mode is a feature that reduces the noise often experienced by “Telecoil” hearing aid users when using a digital cordless telephone. To turn this feature on, follow the steps below and select “Telecoil”. The factory preset is OFF.

1 Press **[MENU]**.

2 Scroll to “**Accessibility**” by pressing **[▼]** or **[▲]**, then press the soft key (**Select**).

```
Accessibility
┆Back ▼▲ Select┆
```

3 Scroll to “**Hearing Aid Mode**” by pressing **[▼]** or **[▲]**, then press the soft key (**Select**).

```
Hearing Aid Mode
┆Back ▼▲ Select┆
```

4 Select “**Telecoil**” or “**Off**” by pressing **[▼]** or **[▲]**.

```
Hearing Aid Mode
:Off
┆Back ▼▲ Save┆
```

5 Press the soft key (**Save**), then press **[OFF]**.

- When “Telecoil” is selected, “**[HAC]**” is displayed after you press **[↶]**.
- If “Telecoil” is selected, the battery operating time will be shortened (p. 11).
- If “Telecoil” is selected, the cordless handset receiver may feel warm during use. This is normal.

```
Talk
00-00-32    【HAC】
┆(VE)      Mute┆
```

Preparing the Answering System

Greeting Message **Base Unit**

You can record a personal greeting message of **up to 2 minutes**. If you do not record your own message, one of two pre-recorded greetings will be played for callers (p. 25).

The total recording time of all messages (greeting, incoming and memo) is **about 16 minutes**.

We recommend you record a **brief greeting message** in order to leave more time for recording new messages.

- You can use the enhanced recording mode for clearer sound, if necessary (p. 27).

Preparing the Answering System

To record a greeting message

Sample greeting message

“Hello, this is (your name and/or number). Sorry, I cannot take your call. Please leave a message after the beep. Thank you.”

- 1 Press **[GREETING REC]**.
 - “To record greeting, press RECORD again” is heard.
- 2 Within 10 seconds, press **[GREETING REC]** again to record your greeting.
- 3 After the long beep, talk clearly, about 20 cm (8 inches) away from the **MIC** (microphone).
 - The elapsed recording time is displayed.
 - If you record for over 2 minutes, the unit will stop recording.
- 4 When finished, press **[GREETING REC]** or **[STOP]**.
 - To change the greeting, start again from step 1.

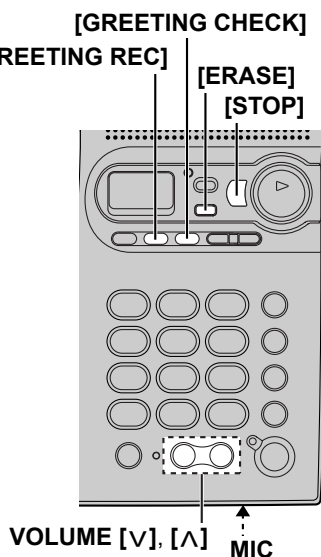

- If “E” is displayed, 6 beeps sound and “Your greeting was not recorded. Record your greeting again.” is announced, start again from step 1.

To adjust the speaker volume, press **VOLUME [V]** or **[^]** during playback.

- 9 levels (0–8) are available while using the Answering System. The level is displayed on the base unit.

Preparing the Answering System

To review the greeting

Press **[GREETING CHECK]**.

To erase the greeting

Press **[GREETING CHECK]**, then press **[ERASE]** while the recorded message is being played.

- The unit will answer calls with a pre-recorded greeting (see below).

Pre-recorded greeting

If you do not record a greeting (p. 23, 24), one of two greetings will be played when a call is received, depending on the caller's recording time (p. 26).

To review the pre-recorded greeting, press [GREETING CHECK].

- A pre-recorded greeting will be played as follows:

- When the recording time is set to "1 minute", "2 minutes" or "3 minutes":
"Hello, we are not available now. Please leave your name and phone number after the beep. We will return your call."
- If recording time runs out, the unit will automatically switch to the "Greeting only" mode (see below), and no new messages will be recorded.
- When the recording time is set to "Greeting only":
"Hello, we are not available now. Please call again. Thank you for your call."

Flash Memory Message Backup (Message storage)

Messages stored in memory will not be affected by power failures. All messages are saved until you erase them.

Preparing the Answering System

Caller's Recording Time **Handset**

You can select "1 minute", "2 minutes", "3 minutes" or "Greeting only" for the caller's recording time. The factory preset is "3 minutes".

1 Press **[MENU]**.

2 Scroll to "Initial setting" by pressing **[▼]** or **[▲]**, then press the soft key (**Select**).

Initial setting
└Back ▼▲ Select┘

3 Press the soft key (**Select**) at "Set answering".

Set answering
└Back ▼▲ Select┘

4 Scroll to "Recording time" by pressing **[▼]** or **[▲]**, then press the soft key (**Select**).

Recording time
└Back ▼▲ Select┘

5 Select the recording time by pressing **[▼]** or **[▲]**.
• You can also select the recording time by pressing **[1]**, **[2]**, **[3]** or **[0]** (Greeting only).

Recording time
:3min
└Back ▼▲ Save┘

6 Press the soft key (**Save**), then press **[OFF]**.

If you select "Greeting only", the unit will answer calls with the greeting message, and then hang up. The unit will not record any incoming messages. The base unit will display "G" instead of the number of messages.

Number of Rings **Handset**

You can select the number of times the unit rings before the Answering System answers a call, from "2" to "7" or "Toll saver"*. The factory preset is "4".

1 Press **[MENU]**.

2 Scroll to "Initial setting" by pressing **[▼]** or **[▲]**, then press the soft key (**Select**).

Initial setting
└Back ▼▲ Select┘

3 Press the soft key (**Select**) at "Set answering".

Set answering
└Back ▼▲ Select┘

4 Press the soft key (**Select**) at "Number of rings".

Number of rings
└Back ▼▲ Select┘

Preparing the Answering System

- 5 Select the number of rings by pressing [▼] or [▲].

- You can also select the number of rings by pressing [0] (Toll saver*), or [2] to [7].

Number of rings
:4
└Back ▼▲ Save└

- 6 Press the soft key (Save), then press [OFF].

*Toll saver

When you call the unit from a remote operation, the number of rings will tell you if there are any new messages. If the unit answers on the 2nd ring, there is at least one new message. If the unit answers on the 4th ring, there are no new messages. To save the toll charges for the call, hang up immediately when you hear the 3rd ring. The 3rd ring indicates that there are no new messages.

Recording Mode **Handset**

Two recording modes are available. The factory preset is “Standard recording (16min)”, which provides more recording time (16 min) and standard sound quality. “Enhanced recording (8 min)” provides less recording time (8 min) but clearer sound quality.

- 1 Press [MENU].

- 2 Scroll to “Initial setting” by pressing [▼] or [▲], then press the soft key (Select).

Initial setting
└Back ▼▲ Select└

- 3 Press the soft key (Select) at “Set answering”.

Set answering
└Back ▼▲ Select└

- 4 Scroll to “Recording mode” by pressing [▼] or [▲], then press the soft key (Select).

Recording mode
└Back ▼▲ Select└

- 5 Select the recording mode by pressing [▼] or [▲].

- You can also select the recording mode by pressing [1] (Standard) or [2] (Enhanced).

Standard
recording (16min)
└Back ▼▲ Save└

- 6 Press the soft key (Save), then press [OFF].

Preparing the Answering System

Message Alert **Handset**

You can select whether or not the Ringer/Message Alert indicator on the handset will flash slowly when new messages have been recorded (p. 64). The factory preset is OFF.

1 Press **[MENU]**.

2 Scroll to “**Initial setting**” by pressing **[▼]** or **[▲]**, then press the soft key (**Select**).

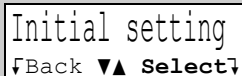

Initial setting
↓Back ▼▲ Select↓

3 Scroll to “**Message alert**” by pressing **[▼]** or **[▲]**, then press the soft key (**Select**).



Message alert
↓Back ▼▲ Select↓

4 Select “**On**” or “**off**” by pressing **[▼]** or **[▲]**.

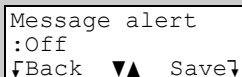

Message alert
:Off
↓Back ▼▲ Save↓

5 Press the soft key (**Save**), then press **[OFF]**.

- The Ringer/Message Alert indicator will not flash for new messages while the handset is in use.
- The Ringer/Message Alert indicator acts both as a ringer indicator and as a message alert indicator. This indicator will flash rapidly when a call is received whether this feature is on or off.
- Battery operating time will be shortened when using this feature (p. 11).

Making Calls

Using the Handset **Handset**

- 1 Press [↶].
 - “Talk” is displayed.
- 2 Dial a phone number.
 - The dialed number is displayed.
 - After a few seconds, the display will show the length of the call.
- 3 To hang up, press [OFF] or place the handset on the base unit.

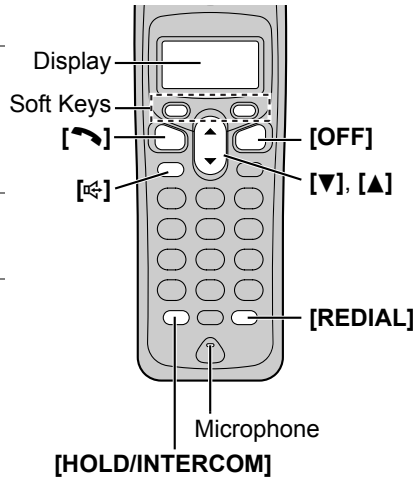

To have a hands-free phone conversation

- 1 Press [☎].
 - “SP-phone” is displayed.
- 2 Dial a phone number.
 - The dialed number is displayed.
 - After a few seconds, the display will show the length of the call.
- 3 When the other party answers, talk into the microphone.
- 4 To hang up, press [OFF] or place the handset on the base unit.

Hands-free Digital Duplex Speakerphone

For best performance, please note the following:

- Talk alternately with the other party in a quiet room.
- If you or the other party has difficulty hearing, press [▼] to decrease the speaker volume.
- While talking using [☎], you can switch to a hands-free phone conversation by pressing [☎]. To switch back to the receiver, press [↶].

Making Calls

To dial after confirming the entered number (Pre-dial)

1 Enter a phone number.

- The handset announces each button you press, including [1] to [0], [*] (“Star”), [#] (“Pound”), [FLASH/CALL WAIT] (“Flash”) and the soft key (Pause).
- The announcement is heard at the speaker volume (see below). To increase or decrease volume, press [▲] or [▼].
- If you misdial, press the soft key (Clear). Enter the correct number.
- If a pause is required when dialing, press the soft key (Pause) where needed (p. 58).
- To cancel, press [OFF].

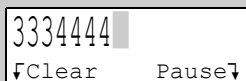

3334444
↓Clear Pause↓

2 Press [↶] or [↷].

3 To hang up, press [OFF] or place the handset on the base unit.

- If the Handset Talking Keypad is turned off (p. 20), the handset will not announce the buttons you press.

The handset will not make announcements, when:

- the Handset Talking Keypad is turned off
- the Answering System is in use
- the handset has lost communication with the base unit
- the base unit is announcing
- the base unit is making an outside call.

To adjust the receiver/speaker volume during a conversation

There are 6 volume levels for the receiver and the speaker.

To increase volume, press [▲].

To decrease volume, press [▼].

Ex. Level 6



Volume
Low ██████████ High
↓(VE) Mute↓

- The number of steps indicates the volume level.
- The display shows the current volume setting.
- If you try to increase/decrease volume when it is at the maximum/minimum level, the handset will beep 3 times.
- If you change the receiver volume to level 1 or 6, the receiver volume will return to level 2 or 5
 - the next time you make or answer a call,
 - when you press [↶] to switch to the receiver during a hands-free conversation using the speakerphone, or
 - when you unplug the optional headset to switch to the receiver (p. 73).
- 3 levels (High, Medium and Low) are available while using the headset.

To redial the last number dialed

Press [↶] or [↷], then press [REDIAL].

To redial using the redial list (Memory Redial)

The last 5 phone numbers dialed are stored in the redial list.

1 Press [REDIAL].

- The last number dialed is displayed.
- “Redial” and the displayed name or phone number are announced.

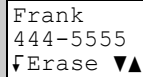

Frank
444-5555
Erase ▸

2 Scroll to the desired number by pressing [▼] or [▲].

- The displayed name or phone number is announced each time you press [▼] or [▲] to scroll through the list.
- The announcement is heard at the speaker volume (p. 30). To increase or decrease volume, press [MENU] after you enter the list, then press [▲] or [▼].
- You can also scroll down through the list by pressing [REDIAL].
- To exit the list, press [OFF].

3 Press [↶] or [↷].

- **To erase an item**, scroll to the item then press the soft key (Erase).
- If “No items stored” is displayed and “Redial. No items stored” is announced, the list is empty.
- If the item does not have a name, or if the name does not include letters, numbers, or the & (“Ampersand”) symbol, the phone number is announced instead.
- If the Name Announcement is turned off (p. 22), the handset will not announce a name or a phone number displayed while you are searching.

The handset will not make announcements, when:

- the Name Announcement is turned off
- the Answering System is in use
- the handset has lost communication with the base unit
- the base unit is announcing
- the base unit is making an outside call.

To put a call on hold

1 Press [HOLD/INTERCOM] during a conversation.

- “Line on hold.” is displayed.
- To transfer the call to the base unit, see page 54.

2 Press [HOLD/INTERCOM] again.

- “Hold” is displayed.
- You can search the Caller List or phone book while a call is on hold. To exit the list, press [OFF]. The call will remain on hold.

To return to the call, press [↶] or [↷].

- The base unit user can also take the call by pressing [SP-PHONE].
- If another phone is connected on the same line (p. 9), you can also take the call by lifting its handset.
- If a call is kept on hold for 6 minutes, an alarm tone will start to sound and the Ringer/Message Alert indicator will start to flash rapidly. After 4 additional minutes on hold, the call will be disconnected.

Making Calls

Voice Enhancer Technology

Panasonic's Voice Enhancer Technology clarifies the voice of the person you are talking to, reproducing a more natural-sounding voice that is easier to hear and understand.

Voice Enhancer Technology can be turned on or off. The factory preset is OFF.

- Depending on the condition and quality of your telephone line, this feature may emphasize existing line noise. If it becomes difficult to hear, turn this feature off.

To turn this feature on, press the soft key **(VE)** during a conversation.

- “**(VE)**” is displayed.
- **To turn this feature off**, press the soft key **(VE)** again. “**(VE)**” disappears from the display.
- After hanging up a call, the on/off setting will be retained.

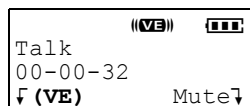

When the handset is not in use, you can also turn this feature on or off by programming as follows:

1. Press **[MENU]**.
2. Scroll to “**voice enhancer**” by pressing **[▼]** or **[▲]**, then press the soft key (**Select**).
3. Select “**on**” or “**off**” by pressing **[▼]** or **[▲]**.
4. Press the soft key (**Save**), then press **[OFF]**.

Backlit LCD display/Lighted handset keypad

The handset display and dialing buttons will light for a few seconds after pressing a button or lifting the handset off the base unit. They will also light when an intercom/outside call is being received.

Using the Base Unit **Base Unit**

- 1 Press **[SP-PHONE]**.
 - The SP-PHONE indicator lights.
 - “**LINE IN USE**” displays.
- 2 Dial a phone number.
 - The base unit announces each button you press, including **[1]** to **[0]**, **[*]** (“Star”), **[#]** (“Pound”), and **[FLASH/CALL WAIT]** (“Flash”).
- 3 When the other party answers, talk into the **MIC** (microphone).
- 4 To hang up, press **[SP-PHONE]**.
 - The indicator light goes out.

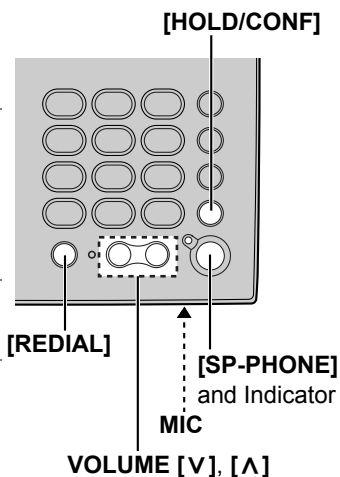

- To switch to the handset while using the base unit speakerphone:
 - If the handset is off the base unit, press [📞] or [📞] on the handset, then press [SP-PHONE] on the base unit.
 - If the handset is on the base unit, just lift up the handset.
- If the Base Unit Talking Keypad is turned off (p. 21), the base unit will not announce the entered number.

The base unit will not make announcements, when:

- the Base Unit Talking Keypad is turned off
- the Answering System is in use
- the handset is announcing.

Hands-free Digital Duplex Speakerphone

For best performance, please note the following:

- Talk alternately with the other party in a quiet room.
- If you or the other party has difficulty hearing the conversation, press **VOLUME [V]** to decrease the speaker volume.

To adjust the speaker volume during a conversation

To increase volume, press **VOLUME [^]**.

To decrease volume, press **VOLUME [v]**.

- There are 8 volume levels. If you try to increase/decrease volume when it is at the maximum/minimum level, the base unit will beep 3 times.

To redial the last number dialed

Press [SP-PHONE], then press [REDIAL].

- “Redial” is announced.
- If the Base Unit Talking Keypad is turned off (p. 21), the base unit will not announce.

To put a call on hold

Press [HOLD/CONF] during a conversation.

- The SP-PHONE indicator flashes.

To return to the call, press [SP-PHONE].

- The handset user can also take the call by pressing [📞] or [📞].
- If another phone is connected on the same line (p. 9), you can also take the call by lifting its handset.
- If a call is kept on hold for 6 minutes, an alarm tone will start to sound. After 4 additional minutes on hold, the call will be disconnected.

Answering Calls

When a call is received, the unit rings, "Incoming call" is displayed, and the Ringer/Message Alert indicator on the handset and "LINE IN USE" on the base unit flash rapidly. If you subscribe to Caller ID, see page 35.

Handset

- 1 Press [] or [].
 - You can also answer a call by pressing any button except [, [] or [**OFF**].
- 2 To hang up, press [**OFF**] or place the handset on the base unit.

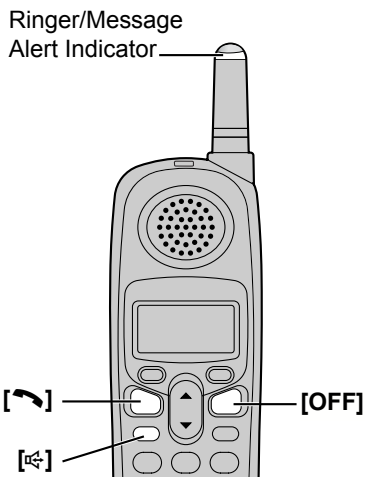

Auto Talk

If the Auto Talk feature is turned on (p. 16), you can answer a call by simply lifting the handset off the base unit.

Temporary ringer off

You can turn the ringer off temporarily by pressing [**OFF**], while the handset is ringing for an outside call. The handset will ring again as normal the next time a call is received.

Base Unit

- 1 Press [**SP-PHONE**].
- 2 Talk into the **MIC**.
- 3 To hang up, press [**SP-PHONE**].

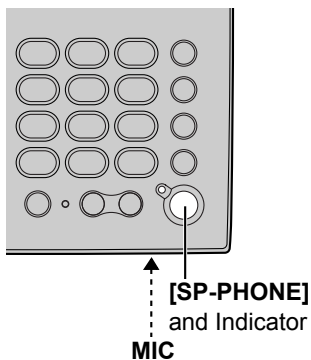

- To transfer the call to another person, see page 54.
- If the ringer volume is turned off, the unit will not ring (p. 17, 18).

Caller ID Service

This unit is compatible with Caller ID services offered by your telephone company. If you subscribe to Caller ID, caller names and phone numbers will be displayed and recorded in the Caller List.

How Caller ID information is displayed and announced

When a call comes in, the unit will ring and Caller ID information will be received. The handset display will show the caller's information, then the handset and base unit will announce the displayed name (ex. "Call from ROBINSON, TINA") following every ring (**Talking Caller ID feature**, p. 36).

Example

ROBINSON, TINA 1-555-222-3333

- After you answer the call, the display will show the length of the call.
- The handset and base unit announce the caller's name repeatedly until the call is answered.
- If the unit does not receive Caller ID information, one of the following will be displayed:

Display	Meaning
Out of area	The caller dialed from an area which does not provide Caller ID service.
Private caller	The caller requested not to send his/her information.
Long distance	The caller made a long distance call.

- Depending on the radio communications with the base unit, the handset may not display Caller ID information immediately after the first ring.
- If your unit is connected to a PBX which does not support Caller ID, you cannot access Caller ID service.
- Name display service may not be available in some areas. For further information, please contact your telephone company.
- If you subscribe to both Caller ID and Call Waiting with Caller ID services (CWID), when a second call is received while talking, a call waiting tone will be heard and the second caller's information will be displayed on the handset in use (p. 57). Contact your telephone company for details about availability in your area, and to verify that CWID is activated on your telephone line.

Caller ID Service

Talking Caller ID

To use this feature, you need to subscribe to Caller ID. For further information, please contact your telephone company.

- If the unit does not receive Caller ID information, the unit will announce “Call from out of area”, “Call from private caller”, or “Call from long distance”. If a call is received from an area where name display service is not available, “Number available” will be announced.
- If the ringer volume of the handset and base unit is off, caller names will not be announced. The announcement is heard at the handset or base unit ringer volume (p. 17, 18).
- If this feature is not turned on, caller names will not be announced (see below, p. 37).
- If you have Call Waiting service, the second caller’s information will be displayed but not announced (For Call Waiting Service Users, page 57).
- Name pronunciation may vary. Name pronunciation quality is based on names most commonly used in the United States.
- The unit will announce each letter of abbreviations, such as “Co.” and “Inc.”.
- Caller ID supports names of up to 15 letters. If the caller’s name has more than 15 letters, the name will not be displayed or announced correctly.
- If you subscribe to a Distinctive Ring Service (such as IDENTA-RING) from your telephone company with 2 or 3 consecutive rings, your unit may mute one or more of the rings in order to announce the name of the caller.

To turn Talking Caller ID on or off

You can turn Talking Caller ID on or off for the handset and base unit separately. If this feature is off, the unit will not announce caller names while receiving Caller ID information. The factory preset is ON.

Handset Talking Caller ID feature **Handset**

1 Press **[MENU]**.

2 Scroll to “**Talk Caller ID**” by pressing **[▼]** or **[▲]**, then press the soft key (**Select**).



Talk Caller ID
┆Back ▼▲ Select┆

3 Select “**off**” or “**on**” by pressing **[▼]** or **[▲]**.

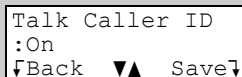

Talk Caller ID
:On
┆Back ▼▲ Save┆

4 Press the soft key (**save**), then press **[OFF]**.

Base unit Talking Caller ID feature **Handset**

This feature must be turned on or off for the base unit by using the handset.

1 Press **[MENU]**.

2 Scroll to “**Initial setting**” by pressing **[▼]** or **[▲]**, then press the soft key (**Select**).

```
Initial setting
┆Back ▼▲ Select┆
```

3 Scroll to “**Set base unit**” by pressing **[▼]** or **[▲]**, then press the soft key (**Select**).

```
Set base unit
┆Back ▼▲ Select┆
```

4 Scroll to “**Talk Caller ID**” by pressing **[▼]** or **[▲]**, then press the soft key (**Select**).

```
Talk Caller ID
┆Back ▼▲ Select┆
```

5 Select “**Off**” or “**On**” by pressing **[▼]** or **[▲]**.

```
Talk Caller ID
:On
┆Back ▼▲ Save┆
```

6 Press the soft key (**save**), then press **[OFF]**.

Using the Caller List

The unit can record up to 50 different callers and store this information in the Caller List. Caller information is sorted by the most recent call to the oldest. When the 51st call is received, the information from the 1st call is deleted.

The unit will also tell you how many calls you missed while you were out or unavailable to answer the phone.

Handset on the base unit

```
2 missed calls — ①
  Charging
```

① The display will show the number of calls you missed.

Handset off the base unit

```
2 missed calls — ①
Rcvd Phone
┆calls book ┆
②
```

② Press the soft key (**Rcvd calls**) to review other calls logged in the Caller List.

- If there are no items in the Caller List, “**Rcvd calls**” will not be displayed.

- After viewing the missed call entries, “**missed calls**” will disappear from the display.

- When new messages have been recorded (p. 64), “**New message**” will be displayed in place of missed calls display.

Using the Caller List

Viewing the Caller List **Handset**

- 1** Press the soft key (**Rcvd calls**), **[▼]**, or **[▲]** to enter the Caller List.

Ex. 2 calls missed.

```

2 missed calls
Rcvd Phone
↓calls book ↓
    
```

```

2 missed calls
▼▲=Scroll list
↓All erase
    
```

- 2** To search from the most recent call, press **[▼]**. To search from the oldest call, press **[▲]**.
- The caller's name, number and the time and date of the call are displayed. Name and phone number are alternately displayed as shown on the right.

Example

```

SMITH, JACK
3:10P JUN.29
↓Erase Select↓
    
```



```

1-555-333-4444
3:10P JUN.29
↓Erase Select↓
    
```

- 3** Press **[OFF]** to exit the list.

- If there is no name information for a caller, the display will only show the phone number.
- If you do not press any buttons for 60 seconds, the unit will exit the Caller List.

Name Announcement

Name Announcement (p. 22) is a feature that announces names or phone numbers shown on the display while you are using the handset to search the phone book, caller list, redial list, and one-touch dialer, allowing you to confirm displayed items audibly before making calls.

Operation	Announcement
When you press the soft key (Rcvd calls), [▼], or [▲] to enter the Caller List	The number of missed calls is announced. <ul style="list-style-type: none"> If a missed call does not exist, "no missed calls" is announced.
When you press [▼], or [▲] to search an item	The displayed name or phone number is announced, each time you scroll an item by pressing [▼] or [▲] .

- If the item does not have a name, or if the name does not include letters, numbers, or the & ("Ampersand") symbol, the phone number is announced instead.
- If a call does not have Caller ID information, the handset will announce "Out of area", "Private caller" or "Long distance".
- The announcement is heard at the speaker volume (p. 30). To increase or decrease volume, press **[MENU]** after you enter the list, then press **[▼]** or **[▲]**.
- If the Name Announcement is turned off (p. 22), the handset will not announce the name or phone number displayed on the handset.

The handset will not make announcements, when:

- the Name Announcement is turned off
- the Answering System is in use
- the handset has lost communication with the base unit
- the base unit is announcing
- the base unit is making an outside call.

What “√” means

“√” indicates you have already viewed this calling information or answered the call. If the same caller calls again, the call entry with the “√” will be replaced with the new call entry.

SMITH, JACK 3:10P JUN.29 √

If a caller calls more than once

The number of times the same caller called is displayed (“x2” to “x9”). The date and time of the most recent call will be recorded. After viewing a caller’s information, “x2” to “x9” will be replaced with “√”.

Ex. Called 2 times.

TURNER, CINDY 11:20A JUN.12 x2

Calling Back from the Caller List **Handset**

1 Press the soft key (**Rcvd calls**), [**▼**], or [**▲**] to enter the Caller List.

2 Scroll to the desired caller by pressing [**▼**] or [**▲**].

3 Press [**↶**] or [**☎**].

- The phone number is dialed.
-

- In some cases, you may have to edit the number before dialing (p. 40). (Ex. You may have to delete “1” and the area code.)
- If a phone number is not displayed in the caller information, you cannot call that caller back from the Caller List.

Using the Caller List

Editing the Caller's Phone Number **Handset**

You can edit a phone number in the Caller List by removing its area code and/or the long distance code "1".

Once you call back an edited number, this unit can automatically edit incoming phone numbers from the same area code in the Caller List and each time you receive a call (**Caller ID Number Auto Edit**, page 41).

1 Press the soft key (**Rcvd calls**), [**▼**], or [**▲**] to enter the Caller List.

2 Scroll to the desired caller by pressing [**▼**] or [**▲**].

PARKER, FRED
11:20A JAN.12
↓Erase Select↓

1-555-321-5555
11:20A JAN.12
↓Erase Select↓

3 Press the soft key (**Select**).

4 Press the soft key (**Edit**) repeatedly until the number is shown in the desired format.

- Each time you press the soft key (**Edit**), the number is rearranged into one of 3 patterns.

(a)

(b) -

(c) 1- -

- The order in which patterns (a)–(c) are displayed depends on how the telephone number is displayed in step 2.

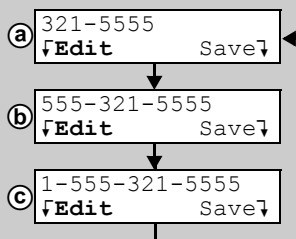

5 To call the edited number, press [**↶**] or [**↷**].

- If Caller ID Number Auto Edit is turned on (factory preset is on), phone numbers with the same area code as the number you edited will now be updated in the Caller List and each time you receive a call.
- You can press [**OFF**] immediately after pressing [**↶**] or [**↷**] if you wish to activate the Auto Edit feature without actually dialing the number you just edited.

To save the edited number into the phone book, press the soft key (Save**).**

- If there is no name information, see "Storing Caller Information in the Phone Book" on page 42, from step 4.
- Even if the Auto Edit feature is turned on, phone numbers in the Caller List and the phone book will not be updated. To update the numbers in the phone book, it is necessary to manually store the phone numbers from Caller List to the phone book (p. 42).

Caller ID Number Auto Edit Handset

Once you call back an edited number (p. 40), this unit can automatically edit incoming phone numbers from the same area code in the Caller List and each time you receive a call. For example, it can ignore the area code of calls originating from your area code, so that you can call these numbers from the Caller List without dialing the area code.

To activate this feature, you must edit a caller's phone number in the Caller List (p. 40) by selecting pattern Ⓐ, Ⓑ, or Ⓒ, then make a call to that number. Calls from numbers in that area code will be edited automatically. The unit can remember up to 4 area codes to be edited according to patterns Ⓐ and Ⓑ.

When more than 5 area codes are edited, older area codes are reset to pattern Ⓒ. Phone numbers from the 4 most recently edited area codes will be automatically edited.

You can turn this feature on or off using the handset. The factory preset is ON.

To turn Caller ID Number Auto Edit on or off

1 Press **[MENU]**.

2 Scroll to "Initial setting" by pressing **[▼]** or **[▲]**, then press the soft key (**Select**).

```
Initial setting
┆Back ▼▲ Select┆
```

3 Scroll to "Caller ID edit" by pressing **[▼]** or **[▲]**, then press the soft key (**Select**).

```
Caller ID edit
┆Back ▼▲ Select┆
```

4 Select "off" or "on" by pressing **[▼]** or **[▲]**.

```
Auto edit
:On
┆Back ▼▲ Save┆
```

5 Press the soft key (**Save**), then press **[OFF]**.

- If you fail to reach your destination when making a call, the phone number you dialed might have an incorrect pattern. Edit the phone number with another pattern (p. 40).
- When this feature is turned off, the unit will still be able to display Caller ID, but incoming Caller ID numbers will not be automatically edited.
- If you move to another area, you may need to turn this feature off to erase the previously edited area codes. To use this feature again, turn it on and reprogram the area codes you want to edit once again.

Using the Caller List

Storing Caller Information in the Phone Book

Handset

Caller names and phone numbers that are in the Caller List can be stored in the phone book.

- 1** Press the soft key (**Rcvd calls**), **[▼]**, or **[▲]** to enter the Caller List.

```
2 missed calls
Rcvd Phone
↓calls book ↓
```

```
2 missed calls
▼▲=Scroll list
↓All erase
```

- 2** Scroll to the desired caller by pressing **[▼]** or **[▲]**.

```
TURNER, CINDY
11:00A JUN.12 x3
↓Erase Select ↓
```



```
1-555-456-7890
11:00A JUN.12 x3
↓Erase Select ↓
```

- 3** Press the soft key (**Select**).

- If the number requires editing, see page 40.

- 4** Press the soft key (**Save**).

- If there is no name information for the caller, "Enter name" will be displayed.
 - You can enter a name by performing the following steps:
 - (1) enter the name (p. 45),
 - (2) press **[▼]**, and
 - (3) press the soft key (**Save**).
 - If a name is not required, press **[▼]**, then press the soft key (**Save**).

- To continue storing other items, repeat from step 2.

- To exit programming mode, press **[OFF]**.

```
TURNER, CINDY
1-555-456-7890
↓Edit Save ↓
```

```
Enter name
█
▼=Next ▶ ↓
```

```
CINDY TURNER
█
↓ ◀ ▼=Next ▶ ↓
```

- You cannot store Caller List item in the phone book if a phone number is not displayed.

Erasing Caller Information **Handset**

To erase a specific caller

- 1 Press the soft key (**Rcvd calls**), [**▼**], or [**▲**] to enter the Caller List.

2 missed calls
Rcvd Phone
↓ calls book ↓
2 missed calls
▼▲=Scroll list
↓ All erase

- 2 Scroll to the desired caller by pressing [**▼**] or [**▲**], then press the soft key (**Erase**).
 - To erase other items, repeat step 2.
 - To exit the Caller List, press [**OFF**].

REAGAN, TOM
12:20A JUN.12
↓ Erase Select ↓
Erased

To erase all entries

Before erasing all entries, make sure that you have viewed all missed calls.

- 1 Press the soft key (**Rcvd calls**), [**▼**], or [**▲**] to enter the Caller List.

Rcvd Phone
↓ calls book ↓

- 2 Press the soft key (**All erase**).

0 missed call
▼▲=Scroll list
↓ All erase

- 3 Press the soft key (**Yes**).
 - All entries in your Caller List are erased.

All erase?
↓ No Yes ↓
All erased

- To cancel erasing, press the soft key (**No**) after step 2.

Phone Book

The handset can store up to 50 names and phone numbers in its phone book. You can make a call by selecting a name or number from the phone book.

Storing Names and Numbers **Handset**

1 Press the soft key (**Phone book**).

- “Phone book” is announced.

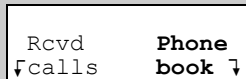

2 Press the soft key (**Add**).

- The display will show the number of stored items.

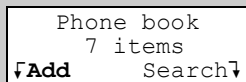

3 Enter a name of up to 16 characters with the dialing buttons (**[0]** to **[9]**) (p. 45), then press **[▼]**.

- If a name is not required, press **[▼]** then go to step 4.

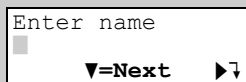

Example

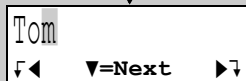

4 Enter a phone number of up to 32 digits.

- Each time you press **◀**, a digit is erased. To erase all of the digits, press and hold **◀**.
- If a pause is required when dialing, press the soft key (**P**). A pause is stored in a phone number as one digit (p. 58).

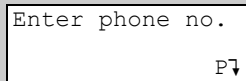

Example

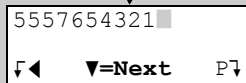

5 Press **[▼]**.

- If you want to change the name, press the soft key (**Edit**). The display returns to step 3. Change the name.
- If you want to change the number, press **[▲]**. The display returns to step 4. Change the number.

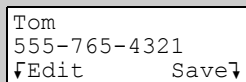

6 Press the soft key (**Save**).

- To continue storing other items, repeat from step 2.

7 Press **[OFF]**.

- To store numbers for calling card access (see “Chain Dial” on page 48), we recommend you add pauses after each item. Storing pauses with numbers will prevent misdialing (p. 58). The delay time necessary will depend on your telephone company.

Selecting characters to enter names

Enter names using the dialing buttons. Press each button until the desired character is displayed.

- Pressing each button selects a character in the order shown below.

Keys	Characters	Keys	Characters
[1]	# & ' () * , - . / 1	[6]	m n o M N O 6
[2]	a b c A B C 2	[7]	p q r s P Q R S 7
[3]	d e f D E F 3	[8]	t u v T U V 8
[4]	g h i G H I 4	[9]	w x y z W X Y Z 9
[5]	j k l J K L 5	[0]	0 Space
◀	Erases the character to the left.		
▶	Moves the cursor to the right. (To enter another character using the same number key, move the cursor to the next space.)		



For example, to enter “Tom”:

1 Press [8] four times.

T

2 Press [6] three times, then press ▶ to move the cursor.

To

3 Press [6] once.

Tom

For Name Announcement users (p. 22)

When entering initials or acronyms, we recommend inserting a space between each letter.

For example, to store the initials “ABC”, enter a space after the A and B as shown.

A B C

If you make a mistake when entering a name or number

Use ◀ to erase the incorrect character. Each time you press ◀, a character is erased. Re-enter the correct character. To erase all characters, press and hold ◀.

Phone Book

Dialing from the Phone Book **Handset**

1 Press the soft key (**Phone book**).

2 Press the soft key (**Search**).

Phone book
7 items
↓Add Search↓

3 Scroll to the desired item. To scroll down, press [▼]. To scroll up, press [▲].

0-9=Name search
▼▲=Scroll list

Phone book items are sorted in the following order:	
1	Alphabet letters (Alphabetical)
2	Space & ' () , - . /
3	Numbers 0 to 9
4	☐ *
5	Telephone numbers (If no name is stored)

4 Press [↶] or [↷].

- The displayed phone number is dialed.

Frank
444-5555
↓Erase Edit↓

- If “**No items stored**” is displayed and “Phone book. No items stored” is announced in step 1, the phone book is empty.
- To exit the phone book, press [OFF].
- To view a phone number over 16 digits long, repeat steps 1 to 3, then press the soft key (**Edit**) and then [▼]. When finished, press [OFF].
- To quickly search the desired item, press [▼] or [▲] after step 1.

To search for a name by initial

1. Press the soft key (**Phone book**).

2. Press the soft key (**Search**).

3. Press the dialing button for the first letter of the desired name until any name with the same initial is displayed (see the Index on page 47).

Ex. To find “Frank”, press [3] repeatedly until the first item under “F” is displayed.

- If there are no items beginning with the character you selected, the first item in the next alphabetical index will be displayed.

4. Press [▼] repeatedly until the desired name is displayed.

Name Announcement

Name Announcement (p. 22) is a feature that announces names or phone numbers shown on the display while you are using the handset to search the phone book, caller list, redial list, and one-touch dialer, allowing you to confirm displayed items audibly before making calls.

Operation	Announcement
When you press the soft key (Phone book)	"Phone book" is announced.
When you press [▼], or [▲] to search an item	The displayed name or phone number is announced, each time you scroll an item by pressing [▼] or [▲].

- If the item does not have a name, or if the name does not include letters, numbers, or the & ("Ampersand") symbol, the phone number is announced instead.
- The announcement is heard at the speaker volume (p. 30). Perform the following steps while searching:
 - (1) press [MENU],
 - (2) press [2] and
 - (3) press [▲] or [▼] to increase or decrease volume.
 - "2=Volume" will not be displayed when the Name Announcement is turned off.
- If the Name Announcement is turned off (p. 22), the handset will not announce the name or phone number displayed on the handset.

1=1-touch dial
2=Volume
↓Back

The handset will not make announcements, when:

- the Name Announcement is turned off
- the Answering System is in use
- the handset has lost communication with the base unit
- the base unit is announcing
- the base unit is making an outside call.

Index table

Keys	Index	Keys	Index
[1]	Symbols, 1	[6]	M, N, O, 6
[2]	A, B, C, 2	[7]	P, Q, R, S, 7
[3]	D, E, F, 3	[8]	T, U, V, 8
[4]	G, H, I, 4	[9]	W, X, Y, Z, 9
[5]	J, K, L, 5	[0]	0, Space

Phone Book

Chain Dial **Handset**

You can dial a combination of phone book or manual key pad entries while making a call. This feature can be used, for example, to first automatically dial a calling card access number that you have stored in the phone book, then manually or automatically dial your PIN and then automatically dial the destination number from the phone book.

Ex. Using a long distance calling card

- To prevent misdialing, we recommend you add pauses where needed when storing numbers. For example, add pauses after a calling card access number and your PIN when storing in the phone book (p. 44).
1. Search and dial from phone book: 1-800-012-3456 (Calling card access number)
 - The voice guidance may be announced.
 2. Search and dial from phone book: 1234 (Calling card PIN)
 3. Search and dial from phone book: 1-555-012-3456 (Destination number)

1 While you are on a call;

Press **[MENU]**.

2 Search for the desired item by pressing **[▼]** or **[▲]**.

- To search for an item by initial, see page 46.

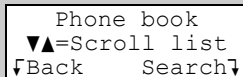

Phone book
▼▲=Scroll list
┆Back Search┆

3 Press the soft key (**Call**).

- The phone number is dialed.
- If required, repeat steps 1 to 3 for any remaining numbers.

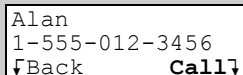

Alan
1-555-012-3456
┆Back Call┆

- If you have rotary or pulse service, you need to press **[*]** before pressing **[MENU]** in step 1 to change the dialing mode temporarily to tone.

Editing an Item in the Phone Book Handset

1 Press the soft key (**Phone book**).

2 Press the soft key (**Search**).

3 Scroll to the desired item by pressing [**▼**] or [**▲**], then press the soft key (**Edit**).

- To search for the item by initial, see page 46.

Jane
345-6789
Erase Edit

4 Edit the name (p. 45), then press [**▼**].

- If you do not need to change the name, press [**▼**] then go to step 5.

Jane Walker
◀ Next ▶

5 Edit the phone number, then press [**▼**].

- If you do not need to change the number, press [**▼**] then go to step 6.
- Each time you press ◀, a digit is erased. To erase all of the digits, press and hold ◀.

5553456789
◀ Next ▶

6 Press the soft key (**Save**).

- To continue editing other items, repeat from step 3.

7 Press [**OFF**].

Erasing an Item in the Phone Book Handset

1 Press the soft key (**Phone book**).

2 Press the soft key (**Search**).

3 Scroll to the desired item by pressing [**▼**] or [**▲**], then press the soft key (**Erase**).

- After an item is erased, its next item is announced.
- To search for the item by initial, see page 46.

Helen
555-777-8888
Erase Edit

4 Press the soft key (**Yes**).

- To erase other items, repeat from step 3.

Erase?
No Yes

5 Press [**OFF**].

- To cancel erasing, press the soft key (**No**) after step 3.

One-Touch Dialer

Storing an Item in the Phone Book to the One-Touch Dialer **Handset**

Caller names and phone numbers that are in the phone book can be assigned to the dialing buttons ([0] to [9]) for easy dialing.

1 Press the soft key (**Phone book**).

- “Phone book” is announced.

```
Rcvd      Phone
↓calls    book ↓
```

2 Press the soft key (**Search**).

```
Phone book
  7 items
↓Add      Search↓
```

3 Scroll to the desired item by pressing [▼] or [▲], then press [MENU].

- The displayed name or phone number is announced, each time you scroll an item by pressing [▼] or [▲].
- To search for the item by initial, see page 46.

```
Jane
345-6789
↓Erase    Edit↓
```

4 Press [1].

- “2=Volume” will not be displayed when the Name Announcement is turned off.

```
1=1-touch dial
2=Volume
↓Back
```

5 Scroll to the desired registration number by pressing [▼] or [▲].

- The empty registration number is selected automatically. (Ex. The empty number is “5”.)
- You can also select the desired registration number by pressing dialing buttons ([0] to [9]).

```
Select 1-touch #
5: (No data)
↓Back  ▼▲  Save↓
```

6 Press the soft key (**Save**).

- To continue storing other items, repeat from step 3.

If the registration number selected manually is occupied, the display on the right will be shown.

To overwrite, press the soft key (**Yes**).

To select other empty registration number, press the soft key (**No**), then repeat steps 5 and 6.

```
Overwrite?
↓No      Yes↓
```

```
1-touch dial
  Saved
```

7 Press [OFF].

- If the phone book item stored in the one-touch dialer is deleted from the phone book or edited, the item in the one-touch dialer is also deleted or edited.

Dialing a Stored Number Handset

1 Press and hold the desired dialing button ([0] to [9]) until the item is displayed.

- If no item is stored in the button you pressed, the unit will not enter the one-touch dialer.
- You can also search the desired item by pressing [▼] or [▲].

Ex. 5 is selected.

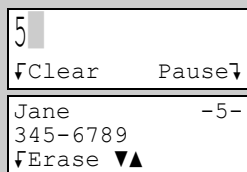

2 Press [↶] or [↷].

- The displayed phone number is dialed.

- If the Answering System is in use when the Name Announcement is turned on (p. 22), the handset will not announce.

Name Announcement

Name Announcement (p. 22) is a feature that announces names or phone numbers shown on the display while you are using the handset to search the phone book, caller list, redial list, and one-touch dialer, allowing you to confirm displayed items audibly before making calls.

Operation	Announcement
When you press and hold a required dialing button ([0] to [9]) to dial from the one-touch dialer.	“1-touch dial” and displayed name or phone number are announced.
When you press [▼], or [▲] to search an item	The displayed name or phone number is announced, each time you scroll an item by pressing [▼] or [▲].

- If the item does not have a name, or if the name does not include letters, numbers, or the & (“Ampersand”) symbol, the phone number is announced instead.
- The announcement is heard at the speaker volume (p. 30). To increase or decrease volume, press [MENU] after you enter the list, then press [▼] or [▲].
- If the Name Announcement feature is turned off (p. 22), the handset will not announce the name or phone number displayed on the handset.

The handset will not make announcements, when:

- the Name Announcement is turned off
- the Answering System is in use
- the handset has lost communication with the base unit
- the base unit is announcing
- the base unit is making an outside call.

One-Touch Dialer

Erasing **Handset**

- 1** Press and hold the dialing button ([**0**] to [**9**]) you want to erase.

Ex. 5 is selected.

Jane -5-
345-6789
↓Erase ▼▲

- 2** Press the soft key (**Erase**).

Jane -5-
345-6789
↓Erase ▼▲

- 3** Press the soft key (**Yes**).
- To erase other items, scroll to the desired items by pressing [▼] or [▲], then repeat from step 2.

Erase?
↓No Yes↓

Erased

- 4** Press [**OFF**].

- To cancel erasing, press the soft key (**No**) after step 2.
- If the phone book item stored in one-touch dial is deleted from the phone book or edited, the item in the one-touch dialer is also deleted or edited.
- Even if the item in the one-touch dialer is deleted, the corresponding item in the phone book will not be deleted.

Locator/Intercom

Intercom calls can be made between the handset and the base unit.

Making Intercom Calls

From **Handset**

- 1** Press [**HOLD/INTERCOM**].
- The base unit will ring for 1 minute.
 - To stop paging, press [**OFF**].

Calling Base

- 2** When the paged party answers, start talking.
- You can switch to the speaker by pressing [↔]. To switch back to the receiver, press [↶].

Intercom
00-00-05
Mute↓

- 3** To disconnect the intercom, press [**OFF**].

From **Base Unit**

Using this feature, you can also locate a misplaced handset.

- 1 Press [**LOCATOR/INTERCOM**].
 - The SP-PHONE indicator lights.
 - The handset will ring for 5 minutes.
 - To stop paging, press [**SP-PHONE**] or [**LOCATOR/INTERCOM**].
- 2 When the paged party answers, talk into the **MIC**.
- 3 To disconnect the intercom, press [**SP-PHONE**] or [**LOCATOR/INTERCOM**].
 - The indicator light goes out.

During an intercom call:

- If you have difficulty hearing while using the handset speakerphone and base unit speaker, decrease the speaker volume by pressing **VOLUME [v]** on the base unit or [**▼**] on the handset.
- If an incoming call is being received, you will hear two tones (incoming call tone, page 59) and "**LINE IN USE**" will flash rapidly on the base unit. To answer the call;
 - if using the handset, press [**OFF**], then [**↶**] or [**↷**].
 - if using the base unit, press [**SP-PHONE**] twice.

Answering Intercom Calls

Handset

When a handset is paged, it rings and the Ringer/Message Alert indicator flashes rapidly.

- 1 Press [**↶**], [**↷**] or [**HOLD/INTERCOM**].
 - You can also answer a call by pressing any button except [**▼**], [**▲**] or [**OFF**].
- 2 To disconnect the intercom, press [**OFF**].

Call from Base

Base Unit

When the base unit is being paged, it rings.

- 1 Press [**SP-PHONE**] or [**LOCATOR/INTERCOM**].
- 2 To disconnect the intercom, press [**SP-PHONE**] or [**LOCATOR/INTERCOM**].

- When the ringer volume is turned off (p. 17, 18), the handset and the base unit will ring at the low level for intercom calls.
- You cannot change the ringer tone for intercom calls.

Transferring a Call

You can transfer an outside call to the base unit or the handset.

From the **Handset** to the **Base Unit**

1 Handset:

(1) During a call, press **[HOLD/INTERCOM]**.

- The call is put on hold.

(2) Press the soft key (**Base**).

(3) Wait for the paged party to answer, then you can announce the transfer.

- After the paged party answers, “**Intercom hold**” is displayed.
- If the paged party does not answer, press **[↶]** or **[↷]** to return to the outside call.

Line on hold.
Transfer to
↓**Base**

Hold
Calling Base

2 Base unit:

Press **[SP-PHONE]** or **[LOCATOR/INTERCOM]** to answer the page.

3 Handset: To complete the transfer, press **[OFF]**.

From the **Base Unit** to the **Handset**

1 Base unit:

During a call, press **[LOCATOR/INTERCOM]**.

- The call is put on hold.
- If the paged party does not answer, press **[LOCATOR/INTERCOM]** to return to the outside call.

2 Handset:

Press **[↶]**, **[↷]** or **[HOLD/INTERCOM]** to answer the page.

- You can also answer a call by pressing any button except **[▼]**, **[▲]** or **[OFF]**.

3 Base unit: To complete the transfer, press **[SP-PHONE]**.

Quick call transfer

You can transfer a call without waiting for the paged party to answer.

Handset

- 1 During a call, press **[HOLD/INTERCOM]**, then press the soft key (**Base**).
- 2 Press **[OFF]** to hang up.

Base Unit

- 1 During a call, press **[LOCATOR/INTERCOM]**.
- 2 Press **[SP-PHONE]** to hang up.

- The call will be transferred directly.
- The paged party can answer the transferred call by pressing **[↶]**, **[↷]** or **[SP-PHONE]**.
- After the paged party answers, the transfer is complete.
- If the paged party does not answer:
 - for the handset, press **[↶]** or **[↷]** to return to the outside call.
 - for the base unit, press **[SP-PHONE]** to return to the outside call.
- If the paged party does not answer within 60 seconds after you hang up, your phone will ring and the call will be returned to your phone. You may speak to the caller again by pressing **[↶]**, **[↷]** or **[SP-PHONE]**.
If you do not answer the call within 4 minutes, the call will be disconnected.

Conference Calls

While you are talking with an outside caller, the base unit user or the handset user can join the conversation and establish a conference call.

Handset

- 1 During a call, press **[HOLD/INTERCOM]**.
 - The call is put on hold.
 - 2 Press the soft key (**Base**).
 - 3 When the paged party answers, press the soft key (**Conf**) on your unit to make a conference call.
 - “**Conference**” is displayed during a conference call.
-

Base Unit

- 1 During a call, press **[LOCATOR/INTERCOM]**.
 - The call is put on hold.
 - 2 When the paged party answers, press **[HOLD/CONF]** on your unit to make a conference call.
-

- To leave the conference, press **[OFF]** on the handset or press **[SP-PHONE]** on the base unit. The two other parties can continue the conversation.
- During a conference, the outside call can be placed on hold by pressing **[HOLD/INTERCOM]** on the handset or **[HOLD/CONF]** on the base unit. Internal communications are not suspended. Only the person who placed the call on hold can resume the full conference by pressing the soft key (**Conf**) on the handset or **[HOLD/CONF]** on the base unit.

Call Share

This feature allows the base unit or the handset to join an existing outside call.

To join a conversation (Call Share)

Handset

- Press **[↶]** or **[↷]**.
- “**Conference**” is displayed.

Base Unit

Press **[SP-PHONE]**.

Special Features

Temporary Tone Dialing

(For Rotary or Pulse Service Users) **Handset** **Base Unit**

Press [*] (TONE) before entering access numbers which require tone dialing.

- The dialing mode changes to tone. You can enter numbers to access an answering service, electronic banking service, etc. When you hang up, the dialing mode will return to pulse.

Muting Your Conversation

During a call, you can mute your phone so the other party cannot listen to you. When muting your conversation, you can hear the other party.

Handset Press the soft key (**Mute**).

- “**Mute**” will flash.
- **To release the mute**, press the soft key (**Mute**) again.
- If you press [↵] or [📞] to switch between the receiver and speaker, the mute will be released.



Talk
00-00-30
↓ (VE) Mute ↵

Base Unit Press [MUTE].

- The SP-PHONE indicator flashes.
- **To release the mute**, press [MUTE] again.

For Call Waiting Service Users

Handset **Base Unit**

Press [FLASH/CALL WAIT] if you hear a call waiting tone during a conversation.

- The first call is put on hold and you can answer the second call.
- To return to the first caller, press [FLASH/CALL WAIT] again.
- Call Waiting service cannot be used when the first call is put on hold, or the Answering System is handling a call.
- If this function does not operate properly, consult your telephone company for details.

Call Waiting Caller ID display **Handset**

If you subscribe to both Caller ID and Call Waiting with Caller ID services (CWID), when a second call is received while talking, the second caller's information will be displayed. After you hear a call waiting tone while talking, the display shows the caller's name with the phone number and “----Waiting-----”.

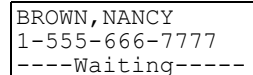

BROWN, NANCY
1-555-666-7777
----Waiting-----

- Contact your telephone company for details about availability in your area, and to verify that CWID is activated on your telephone line.
- The caller's information will only be shown on the display of the handset which is on the outside call.
- The second caller's name will not be announced even if the Talking Caller ID feature is on (p. 36).

Special Features

Using the PAUSE Key

(For PBX Line/Long Distance Calls) **Handset**

We recommend you press the soft key (**Pause**) or (**P**) if a pause is required for dial with a PBX or to make a long distance call.

Ex. Line access number **[9]** (PBX)

[9] ➡ Soft key (**Pause**) or (**P**) ➡ **Phone number**

- Pressing the soft key (**Pause**) or (**P**) once creates a 3.5 second pause. This prevents misdialing when you dial after confirming the entered number (p. 30) or dial a stored number (p. 46, 48).
- Pressing the soft key (**Pause**) or (**P**) more than once increases the length of the pause between numbers.

Example
9P15556667777
↓Clear **Pause**↓

OR

9P15551234567
↓◀ ▼=Next P↓

FLASH Button **Handset** **Base Unit**

Pressing **[FLASH/CALL WAIT]** allows you to use special features of your host PBX such as transferring an extension call, or accessing optional telephone services such as call waiting.

- Pressing **[FLASH/CALL WAIT]** cancels temporary Tone Dialing mode or the mute (p. 57).

Selecting the flash time **Handset**

The flash time required depends on your telephone exchange or host PBX. You can select the following flash times: “700, 600, 400, 300, 250, 110, 100 or 90 ms (milliseconds)”. The factory preset is “700 ms”.

- The setting should stay at 700 ms unless pressing **[FLASH/CALL WAIT]** fails to pick up the Call Waiting call.
- If PBX functions do not work correctly, consult your PBX supplier for the correct settings.

1 Press **[MENU]**.

2 Scroll to “**Initial setting**” by pressing **[▼]** or **[▲]**, then press the soft key (**Select**).

Initial setting
↓Back ▼▲ **Select**↓

3 Scroll to “**Set tel line**” by pressing **[▼]** or **[▲]**, then press the soft key (**Select**).

Set tel line
↓Back ▼▲ **Select**↓

4 Scroll to “**Set flash time**” by pressing **[▼]** or **[▲]**, then press the soft key (**Select**).

Set flash time
↓Back ▼▲ **Select**↓

5 Select the desired time by pressing **[▼]** or **[▲]**.

Set flash time
: 700ms
↓Back ▼▲ **Save**↓

6 Press the soft key (**Save**), then press **[OFF]**.

Incoming Call Tone **Handset** **Base Unit**

During an intercom call (p. 52), you can be informed of incoming calls by two tones. If this feature is turned on, incoming call tones will be heard for as long as the line is ringing. If this feature is set to “2”, incoming call tones will be heard only 2 times. If this feature is turned off, no tones will be heard. The factory preset is “2”. Using the handset, this feature can be set separately for the handset and base unit.

Handset incoming call tone **Handset**

1 Press **[MENU]**.

2 Scroll to “**Ringer setting**” by pressing **[▼]** or **[▲]**, then press the soft key (**Select**).

Ringer setting
 ⌵Back ▼▲ Select⌵

3 Scroll to “**Incoming call.**” by pressing **[▼]** or **[▲]**, then press the soft key (**Select**).

Incoming call.
 ⌵Back ▼▲ Select⌵

4 Select “**On**”, “**Off**” or “**2**” by pressing **[▼]** or **[▲]**.

Incoming call
 tone :2
 ⌵Back ▼▲ Save⌵

5 Press the soft key (**Save**), then press **[OFF]**.

Base unit incoming call tone **Handset**

1 Press **[MENU]**.

2 Scroll to “**Initial setting**” by pressing **[▼]** or **[▲]**, then press the soft key (**Select**).

Initial setting
 ⌵Back ▼▲ Select⌵

3 Scroll to “**Set base unit**” by pressing **[▼]** or **[▲]**, then press the soft key (**Select**).

Set base unit
 ⌵Back ▼▲ Select⌵

4 Scroll to “**Incoming call.**” by pressing **[▼]** or **[▲]**, then press the soft key (**Select**).

Incoming call.
 ⌵Back ▼▲ Select⌵

5 Select “**On**”, “**Off**” or “**2**” by pressing **[▼]** or **[▲]**.

Incoming call
 tone :2
 ⌵Back ▼▲ Save⌵

6 Press the soft key (**Save**), then press **[OFF]**.

Special Features

Key Tone **Handset**

You can select whether or not the handset keys will sound tones (key tone, confirmation tone, error tone). The factory preset is ON.

1 Press **[MENU]**.

2 Scroll to “**Initial setting**” by pressing **[▼]** or **[▲]**, then press the soft key (**Select**).

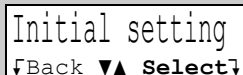

Initial setting
↓Back ▼▲ Select↓

3 Scroll to “**Key tone**” by pressing **[▼]** or **[▲]**, then press the soft key (**Select**).



Key tone
↓Back ▼▲ Select↓

4 Select “**off**” or “**on**” by pressing **[▼]** or **[▲]**.



Key tone
:On
↓Back ▼▲ Save↓

5 Press the soft key (**save**), then press **[OFF]**.

Re-registering the Handset **Handset & Base Unit**

If “**No link to base. Move closer to base, try again.**” is displayed even when using the handset near the base unit, the handset may have lost communication with the base unit. You need to re-register the handset to the base unit.

- **Make sure the base unit is not being used.**
- **Have both the handset and base unit nearby during registration.**
- **Follow steps 1 and 2 listed below. You have about 1 minute to complete them.**

1 *Base unit:*

Press and hold **[LOCATOR/INTERCOM]** until a beep sounds.

- The CHARGE indicator flashes.

2 *Handset:*

Press and hold **[FLASH/CALL WAIT]** until “**Handset Registering**” is displayed.

- When registration is complete, a beep sounds from the handset.
- **Wait for 20 seconds after registration is complete while the handset establishes communication with the base unit.**



Handset
Registering

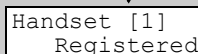

Handset [1]
Registered

- If the handset beeps 3 times and “**Error ! !**” is displayed, an error occurred. Try again from step 1.
- You can stop registration by pressing **[OFF]** on the handset, and pressing **[LOCATOR/INTERCOM]** on the base unit.

Automatic Answering Operation

When the unit answers a call, a greeting message is played and the caller's message is recorded.

- The total recording time of all messages (greeting, incoming and memo) is **about 16 minutes** (about 8 minutes in "Enhanced recording" mode, p. 27). If messages are recorded in noisy rooms, the time may be shortened by up to 3 minutes.
- To select the caller's recording time, see page 26.
- A maximum of 64 messages (including greeting and memo message) can be recorded.

Setting the Unit to Answer Calls **Base Unit**

Press **[ANSWER ON]** to turn on the Answering System.

- The indicator lights and the unit announces "Answer set" and current day and time. If "Answer set. Set time" is heard, set the date and time (p. 14).
- The unit will announce the remaining recording time if it is less than 3 minutes.
- When no recording time is available, you will need to erase any unnecessary messages before new messages can be recorded (p. 66). The unit can indicate that memory is full in the following ways:
 - "**FULL**" will flash on the base unit and the ANSWER ON indicator will flash rapidly until you erase a message.
 - The unit will announce "Memory full" when you press **[ANSWER ON]**, **[GREETING REC]**, or **[MEMO]**, and after playing back messages or recording a message.
- If you do not want the unit to answer calls, press **[ANSWER ON]** again to turn off the Answering System. The indicator light goes out and "Answer off" is heard.
- You can also turn on the Answering System remotely from an outside phone (p. 70).
- If you subscribe to Caller ID (p. 35), Caller ID information automatically adjusts the date and time when a call is received, provided you have already set the date and time manually (p. 14).

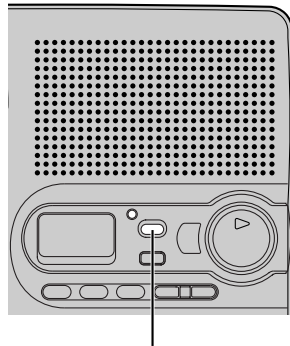

[ANSWER ON] and Indicator

Handset

- 1 Press **[MENU]**.
 - 2 Press the soft key (**Select**) at "**Message play**".
 - 3 Press **[8]** to turn on the Answering System.
 - "Answer set" is heard.
 - 4 Press **[OFF]**.
- To turn the Answering System off, press **[0]** in step 3. "Answer off" is heard.

Automatic Answering Operation

Monitoring Incoming Calls **Base Unit**

While a caller is leaving a message, you can monitor the call through the base unit speaker.

- To increase the speaker volume while monitoring, press **VOLUME** [**^**]. To decrease the volume, press **VOLUME** [**v**].

To answer a call while monitoring, press [**SP-PHONE**] on the base unit or press [**↶**] or [**↷**] on the handset.

To turn the incoming call monitoring feature off

When the base unit is not in use, press [**GREETING CHECK**], then press **VOLUME** [**v**] repeatedly until “0” is displayed. (Make sure the Answering System is turned on.)

OR

While monitoring, press **VOLUME** [**v**] repeatedly until “0” is displayed.

- If the incoming call monitoring feature is turned off, it will remain off when the next call is monitored.
- If you adjust the speaker volume while playing back messages or using the speakerphone, the speaker volume for monitoring will be turned on again. To turn the speaker volume off, see “To turn the incoming call monitoring feature off” of above step.

Listening to Messages

Voice Day/Time Stamp: During playback, the unit will announce the day and time when each message was recorded (p. 14).

Using the Base Unit **Base Unit**

You can see the total number of recorded messages on the base unit display. If the NEW MESSAGE indicator flashes on the base unit, new messages have been recorded.

- If the Message Alert is turned on (p. 28), the Ringer/Message Alert indicator on the handset will flash slowly when new messages have been recorded and the handset is not in use.

To play back messages

Press **[MESSAGE/SLOW TALK]**.

- The unit announces the number of new messages and only new messages are played back.
- When you have no new messages, the unit announces “No new messages. All message playback” and plays back all messages.
- When you have no messages, the unit announces “No messages”.

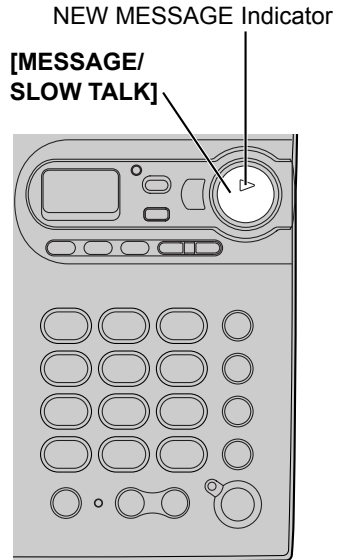

- During playback, the display shows the message number.
- At the end of the last message, “End of final message” is heard. The unit will announce the remaining recording time if it is less than 3 minutes.
- If a call is received during playback, the unit rings and playback stops. To answer the call, press **[SP-PHONE]**. For playback, start again from the beginning after hanging up.

Listening to Messages

Using the Handset (Remote Operation) **Handset**

If “**New message**” is displayed on the handset, new messages have been recorded.

- If the Message Alert is turned on (p. 28), the Ringer/Message Alert indicator on the handset will flash slowly when new messages have been recorded and the handset is not in use.

To play back messages

1 Press **[MENU]**.

2 Press the soft key (**Select**) at “**Message play**”.

- The unit announces the number of new messages and only new messages are played back from the speaker. To switch to the receiver, press **[↶]**. To switch back to the speaker, press **[↷]**.
- When you have no new messages, the unit announces “No new messages. All message playback” and plays back all messages.
- When you have no messages, the unit announces “No messages”.
- To play all messages, press **[5]**.
- If you do not press any button, the voice menu will start (see below).

Message play
↵Back ▼▲ Select↵

MENU=Call back
*4 =Erase msg
↵Repeat Skip↵

3 To end remote operation, press **[OFF]**.

- If a call is received during playback, the unit rings and playback stops. To answer the call, press **[↶]** or **[↷]**. For playback, start again from the beginning after hanging up.
- At the end of the last message, “End of final message” is heard. The unit will announce the remaining recording time if it is less than 3 minutes.
- If you hear “Memory full” after playback, erase unnecessary messages (p. 66).
- When memo messages are played (p. 67), “**MEMO**” is displayed.

Voice menu

If you do not press any buttons at the end of the last message, the unit will announce “End of final message” and the voice menu will begin.

The unit announces, “Press 4 to play back new messages. Press 5 to play back all messages.”

- You can press buttons for other playback options (p. 65) even if the voice menu has started.
- If you do not press any button within 10 seconds after the voice menu, the handset will exit remote operation.

Listening to Messages



For Caller ID service users (p. 35)

During playback using the handset, the handset display will show the name and/or number of the caller whose message is being played.

To call back the displayed number:

1. During playback, press **[MENU]**.

Helen	
1-555-777-8888	
↓Repeat	Skip↓

2. Press the soft key (Call), [] or [].

Helen	
1-555-777-8888	
↓Edit	Call↓

- The unit stops playback and dials the phone number.
- If you need to edit the phone number to call back, see page 40.

During playback **Base Unit** **Handset**

To adjust the speaker volume	<p><i>Base unit:</i> To increase volume, press VOLUME [^]. To decrease volume, press VOLUME [v].</p> <p><i>Handset:</i> To increase volume, press [▲]. To decrease volume, press [▼].</p> <ul style="list-style-type: none"> • You can also adjust the receiver volume on the handset.
To slow down the playback speed (Slow Talk Message Playback)	<p><i>Base unit:</i> Press [MESSAGE/SLOW TALK].</p> <p><i>Handset:</i> Press [3].</p> <ul style="list-style-type: none"> • To return to normal speed, press [MESSAGE/SLOW TALK] on the base unit or [3] on the handset. • Each time you press the button during playback, the speed will change to slow/normal. • Playback speed will return to normal after you finish listening to messages.
To repeat a message	<p><i>Base unit:</i> Press [REPEAT].</p> <p><i>Handset:</i> Press the soft key (Repeat) or [1].</p> <ul style="list-style-type: none"> • If pressed within the first 5 seconds of playback, the previous message will be played.
To skip a message	<p><i>Base unit:</i> Press [SKIP].</p> <p><i>Handset:</i> Press the soft key (skip) or [2].</p>
To stop playback	<p><i>Base unit:</i> Press [STOP].</p> <ul style="list-style-type: none"> • To resume playback, press [MESSAGE/SLOW TALK]. • If you do not press any button for 60 seconds or if you press [STOP] again, playback mode will be canceled. <p><i>Handset:</i> Press [9].</p> <ul style="list-style-type: none"> • If you do not press any button within 15 seconds after stopping playback, the voice menu will start (p. 64).

Erasing Messages

The unit will announce the remaining recording time after playback if it is less than 3 minutes.

New messages cannot be recorded when:

- “Memory full” is heard.
- “**FULL**” flashes on the base unit.
- the ANSWER ON indicator flashes rapidly (when the Answering System is on).

Erase unnecessary messages. We recommend you erase unnecessary messages after each playback.

Erasing a specific message

Base Unit

Press **[ERASE]** while the message you want to erase is being played.

- The unit beeps, then plays back the next message.
- To exit playback mode, press **[STOP]** twice.

Handset

Press **[*] [4]** while the message you want to erase is being played.

- The unit beeps, then plays back the next message.
- To exit remote operation mode, press **[OFF]**.

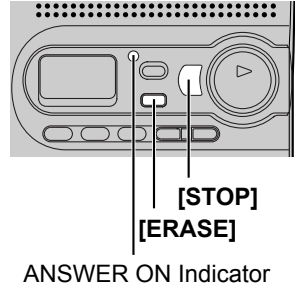

Erasing all messages

All recorded messages, except the greeting message, can be erased at one time.

Base Unit

1 Press **[ERASE]** while the base unit is not being used.

- “To erase all messages, press ERASE again” is heard.

2 Within 10 seconds, press **[ERASE]** again.

- The unit beeps, then announces “No messages”.
- The base unit display shows “0”.

Handset

1 Press **[MENU]**.

2 Press the soft key (**Select**) at “**Message play**”.

3 Press **[*] [5]**.

- The unit beeps, then announces “No messages”.
- To end remote operation, press **[OFF]**.

• Information in the Caller List will not be erased. To erase caller information, see page 43.

Recording a Memo Message

Base Unit

You can record a voice memo message of up to 3 minutes in memory.

- 1 Press **[MEMO]**.
- 2 After the long beep, talk clearly, about 20 cm (8 inches) away from the **MIC**.
 - The base unit display shows the elapsed recording time.
 - If the elapsed recording time exceeds 99 seconds, the counter continues from 00 to indicate 100 seconds.
- 3 When finished, press **[MEMO]** or **[STOP]**.
 - The NEW MESSAGE indicator flashes.
 - If you record for over 3 minutes in step 2, the unit will stop recording.
 - If “E” is displayed, 6 beeps sound and “Your message was not recorded. Record your message again.” is announced, start again from step 1.

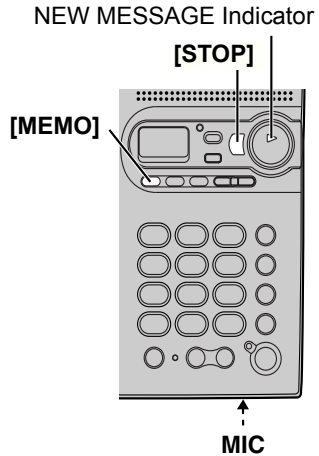

Remote Operation from a Touch Tone Phone

While outside, you can operate the Answering System from any touch tone phone. A synthesized voice menu will guide you through the Answering System (p. 69).

- To skip the voice menu and operate the unit directly, see page 70.

Summary of remote operation

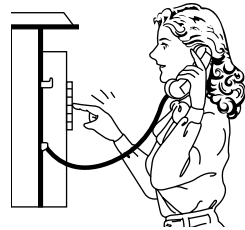
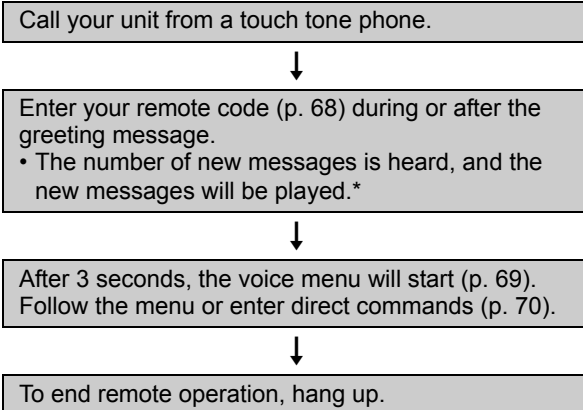

- The unit will announce the remaining recording time after playback if it is less than 3 minutes.
- The messages are saved.
- * If “No new messages” is announced, the unit has only old messages.
If “No messages” is announced, the unit has no messages.

Remote Operation from a Touch Tone Phone

Remote Code **Handset**

The remote code prevents unauthorized people from accessing your unit and listening to your messages. Choose any **2-digit number (00–99)** for your remote code. The factory preset remote code is “11”. If you do not program your own remote code, you can use “11”.

1 Press **[MENU]**.

2 Scroll to “**Initial setting**” by pressing **[▼]** or **[▲]**, then press the soft key (**Select**).

Initial setting
┆Back ▼▲ Select┆

3 Press the soft key (**Select**) at “**Set answering**”.

Set answering
┆Back ▼▲ Select┆

4 Scroll to “**Remote code**” by pressing **[▼]** or **[▲]**, then press the soft key (**Select**).

Remote code
┆Back ▼▲ Select┆

5 Enter a **2-digit remote code (00–99)**.

Remote code
:11
┆Back Save┆

6 Press the soft key (**save**), then press **[OFF]**.

To confirm the remote code, repeat steps 1 to 4.

The remote code is displayed. When finished, press **[OFF]**.

Remote Operation from a Touch Tone Phone

Voice Menu

The shaded parts are voice prompts.

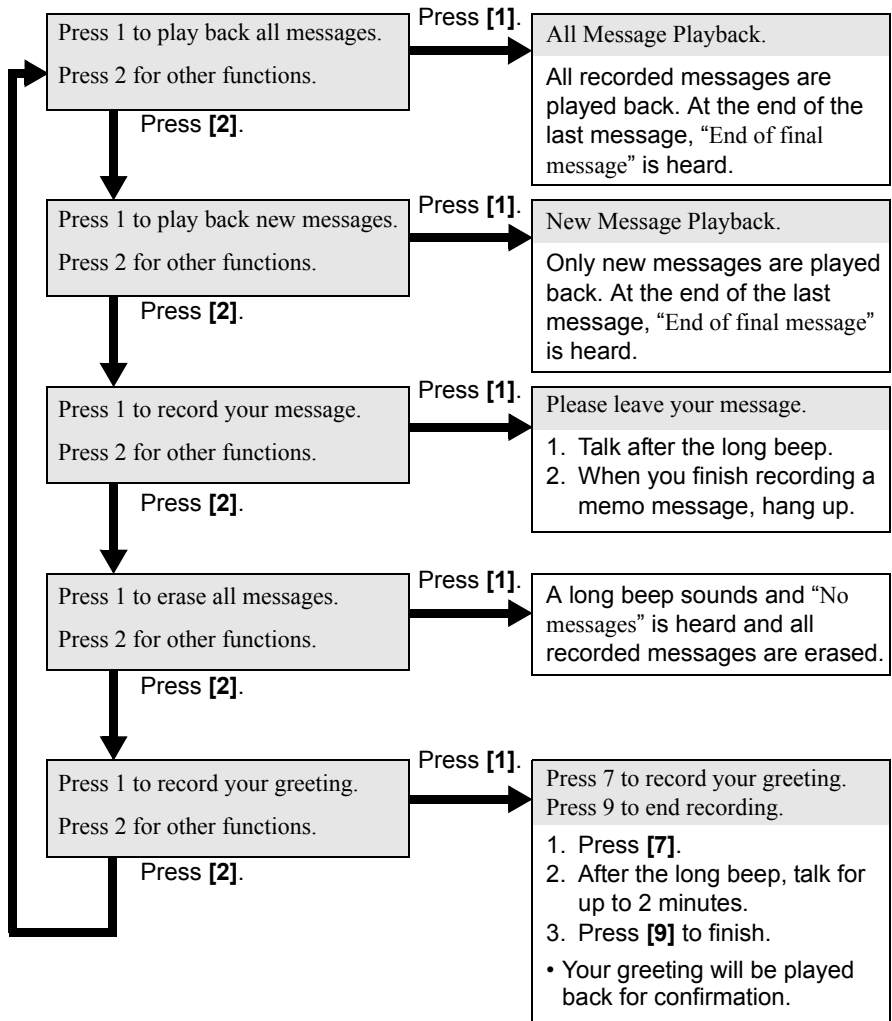

- 3 seconds after playback, the voice menu will start again from the beginning.
- The unit will announce the remaining recording time after playback if it is less than 3 minutes.
- If you hear “Memory full” after playback, erase unnecessary messages (p. 70).
- If you do not press any buttons within 10 seconds after a voice prompt, “Thank you for your call.” will be heard and the call will be disconnected.

Remote Operation from a Touch Tone Phone

Direct Remote Operation

Once you have entered the remote code, you can also control your unit by direct commands instead of using the voice menu. To end remote operation, hang up at anytime.

Direct commands

[4] :	Plays back new messages.	[7] :	Records a greeting message.
[5] :	Plays back all messages.		After the long beep, talk for up to 2 minutes.
[1] :	Repeats the current message. <ul style="list-style-type: none">• If pressed within the first 5 seconds of playback, the previous message will be played.	[9]	Recording is stopped. <ul style="list-style-type: none">• The greeting is played.
[2] :	Skips the current message.	[*] [4] :	Erases the current message. <ul style="list-style-type: none">• A short beep will sound and the next message will be played.
[3] :	Changes the playback speed to slow/normal.	[*] [5] :	Erases all messages. <ul style="list-style-type: none">• A long beep will sound and "No messages" will be heard.
[9] :	Stops the current operation. <ul style="list-style-type: none">• To resume, enter a direct command within 15 seconds, or the voice menu will start (p. 69).	[0] :	Turns off the Answering System. <ul style="list-style-type: none">• The unit hangs up.

To turn on the Answering System:

Call your unit and wait for 15 rings.

- The unit will answer and the greeting will be played.
- The Answering System will be turned on. Hang up or enter the remote code for other options.
- When turning on the Answering System using a rotary or pulse service telephone, you cannot enter the remote code for other options.

Skipping the greeting

After calling your unit, press [*] during the greeting.

- The unit skips the rest of the greeting and you can start recording your message after the long beep.

Wall Mounting

This unit can be mounted on a wall phone plate.

- 1 Push the hook and turn it upward. Turn the hook until a click is heard.

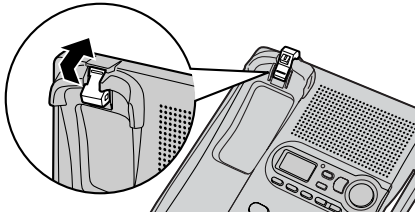

- 2 Press the tabs in the direction of the arrows (1), then remove the wall mounting adaptor (2).

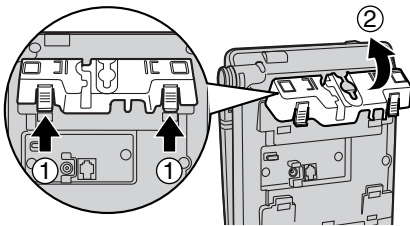

- 3 Connect the AC adaptor. Tuck the telephone line cord inside the wall mounting adaptor, then push the adaptor in the direction of the arrows (1 and 2).

- The word "UP WALL" should face upward.
- Fasten the AC adaptor cord to prevent it from being disconnected.

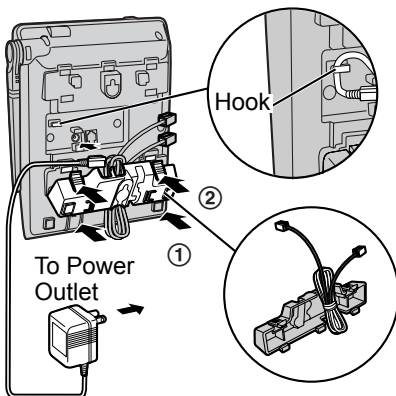

- 4 Connect the telephone line cord. Mount the unit, then slide it down.

- Raise the antenna.

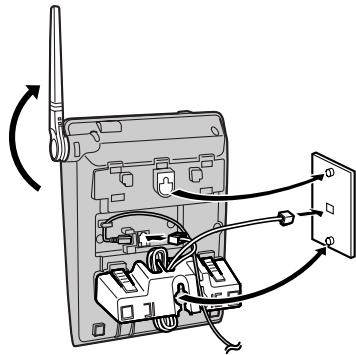

- 5 To charge the handset battery:

Rest the handset on the charge contacts (1), then push the top of the handset so the hook snaps into the slot at the top of the handset (2).

- The CHARGE indicator lights and the unit beeps once.

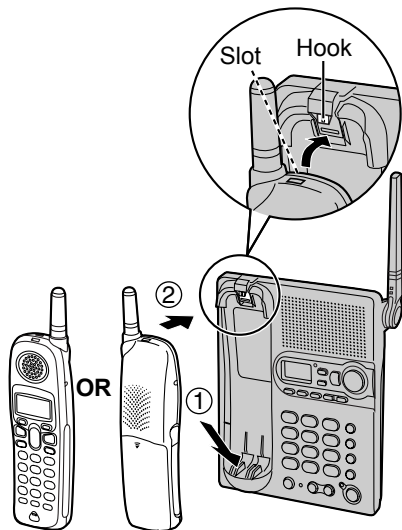

Belt Clip

You can hang the handset on your belt or pocket using the included belt clip.

To attach the belt clip

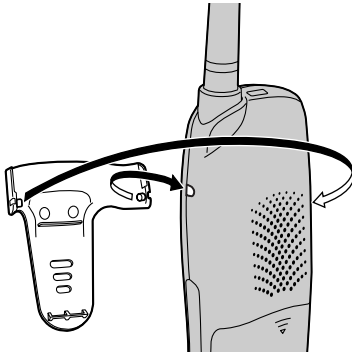

To remove the belt clip

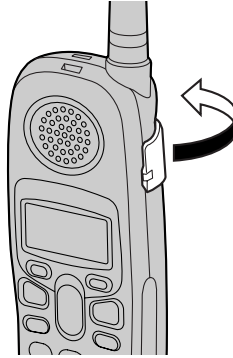

Shoulder Rest Attachment

Use the shoulder rest attachment if you need to keep your hands free during a phone conversation.

To attach the shoulder rest attachment

Attach the included belt clip to the handset (see above), then attach the shoulder rest attachment to the belt clip as shown below. You will hear a click when the shoulder rest attachment is in place.

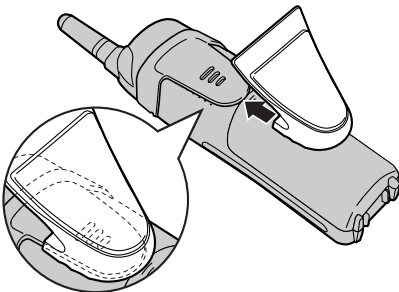

To remove the shoulder rest attachment

Slide the base of the attachment in the direction of the arrow as shown below.

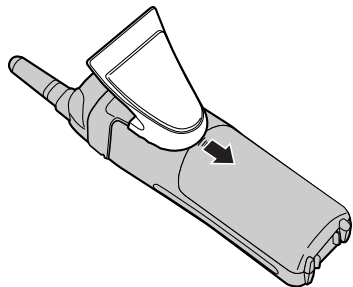

Optional Headset

Connecting an optional headset to the handset allows hands-free phone conversation. Please use only a Panasonic KX-TCA60, KX-TCA86, KX-TCA88, KX-TCA88HA, KX-TCA91, KX-TCA92, or KX-TCA98 headset. To order, call the accessories telephone number on page 2.

Connecting an optional headset

Open the headset jack cover, and insert the headset plug into the headset jack as shown below.

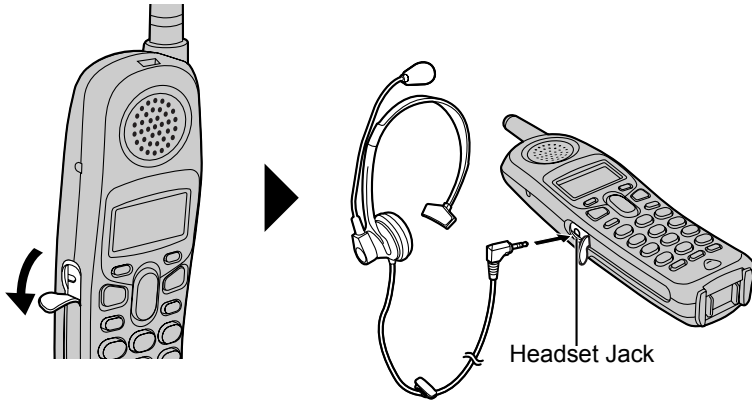

- Headset sold separately. Model shown here is KX-TCA88.

To switch to the speakerphone while using the headset:

Press [**⏪**]. To return to the headset, press [**⏩**].

Direct Commands

Handset

After pressing **[MENU]**, you can also program menu items directly by pressing **[0]** to **[9]**, **[*]** and **[#]** instead of using the soft keys.

Menu item	Command	Selection items	Page
Ringer volume	[1] [1]	[0] : Off [1] : Low [2] : Medium [3] : High	p. 17
Ringer tone (for handset)	[1] [2]	[1]–[3] : Tone pattern 1–3 [4]–[7] : Melody pattern 1–4	p. 18
Incoming call tone (for handset)	[1] [3]	[1] : On [2] : 2 [0] : Off	p. 59
Message play	[2]		p. 64
Date and time	[4]	Go to Step 3 on page 14.	—
Voice enhancer	[5]	[1] : On [0] : Off	p. 32
Talking Keypad (for base unit)	[8] [1] [1]	[1] : On [0] : Off	p. 21
Talking Keypad (for handset)	[8] [2] [1]	[1] : On [0] : Off	p. 20
Name announcement	[8] [2] [2]	[1] : On [0] : Off	p. 22
Hearing aid mode	[8] [3]	[1] : Telecoil [0] : Off	p. 23
Talking Caller ID (for handset)	[9]	[1] : On [0] : Off	p. 36
LCD contrast	[0] [1]	[1]–[6] : Level 1–6	p. 20
Key tone	[0] [2]	[1] : On [0] : Off	p. 60
Auto talk	[0] [3]	[1] : On [0] : Off	p. 16
Caller ID number auto edit	[0] [4]	[1] : On [0] : Off	p. 41
Dialing mode	[0] [5] [1]	[1] : Pulse [2] : Tone	p. 15
Flash time	[0] [5] [2]	[1] : 700 ms [2] : 600 ms [3] : 400 ms [4] : 300 ms [5] : 250 ms [6] : 110 ms [7] : 100 ms [8] : 90 ms	p. 58
Line mode	[0] [5] [3]	[1] : A [2] : B	p. 16

Direct Commands

Menu item	Command	Selection items	Page
Number of rings	[0] [6] [1]	[2]–[7] : 2–7 rings [0] : Toll saver	p. 26
Recording time	[0] [6] [2]	[1] : 1 minute [2] : 2 minutes [3] : 3 minutes [0] : Greeting only	p. 26
Remote code	[0] [6] [3]	Go to Step 5 on page 68.	—
Recording mode	[0] [6] [4]	[1] : Standard recording [2] : Enhanced recording	p. 27
Change language	[0] [8]	[1] : English [2] : Spanish	p. 15
Message alert	[0] [†]	[1] : On [0] : Off	p. 28
Ringer tone (for base unit)	[0] [✳] [1]	[1]–[3] : Tone pattern 1-3 [4]–[7] : Melody pattern 1-4	p. 19
Incoming call tone (for base unit)	[0] [✳] [2]	[1] : On [2] : 2 [0] : Off	p. 59
Talking Caller ID (for base unit)	[0] [✳] [4]	[1] : On [0] : Off	p. 37

During programming:

When “Save” is displayed, press the right soft key to save the new settings.

To exit programming, press [OFF].

- If you press the direct command incorrectly, press [OFF], then re-enter programming mode by pressing [MENU].
- For function details, see the corresponding pages.

If the Following Appear on Your Display...

The following will be displayed when the unit needs your attention.

Display message	Cause & Remedy
Recharge battery	<ul style="list-style-type: none">• The battery needs to be charged. Recharge the battery (p. 10).
Charge for 6h	<ul style="list-style-type: none">• The battery has been discharged. The handset will not work. Fully charge the battery (p. 10).
No link to base. Move closer to base, try again.	<ul style="list-style-type: none">• The handset has lost communication with the base unit. Walk closer to the base unit and try again or re-register the handset (p. 60).• Confirm the base unit's AC adaptor is plugged in.• Raise the base unit antenna.
Please lift up and try again.	<ul style="list-style-type: none">• A handset button was pressed while the handset was on the base unit. Lift the handset and press the button again.
Busy	<ul style="list-style-type: none">• The base unit is in use. Try again later.
Error!!	<ul style="list-style-type: none">• When you tried to re-register the handset, the handset and base unit could not link for some reason, such as interference from electrical appliances. Move the handset and base unit away from any electrical appliances and try again.
Phone book full	<ul style="list-style-type: none">• When you tried to store an item in the phone book, the phone book memory was full. Press [OFF] to exit the programming mode. To erase other items from the phone book, see page 49.
System is busy. Please try again later.	<ul style="list-style-type: none">• The handset has lost communication with the base unit. Walk closer to the base unit and try again.• The Answering System is in use, such as answering a call or playing back messages. Try again later.
Line in use	<ul style="list-style-type: none">• The base unit is conducting an outside call or a parallel connected telephone is in use.
Line on hold	<ul style="list-style-type: none">• The base unit is on hold for an outside call.

Troubleshooting

If the handset display shows error messages, see “If the Following Appear on Your Display...” (p. 76) for the Cause & Remedy.

Telephone System

Problem	Cause & Remedy
“No link to base. Move closer to base, try again.” is displayed and an alarm tone sounds.	<ul style="list-style-type: none">• You are too far from the base unit. Walk closer to the base unit.• Confirm the base unit’s AC adaptor is plugged in.• Raise the base unit antenna.• If the above remedies do not solve the problem, the handset may have lost communication with the base unit. Register the handset again (p. 60).
Static, sound cuts in/out, fades. Interference from other electrical units.	<ul style="list-style-type: none">• Move the handset and base unit away from other electrical appliances (p. 3).• Walk closer to the base unit.• Raise the base unit antenna.• If the unit is connected to a telephone line with DSL service, you may hear noise from the receiver or speaker during conversations. We recommend connecting a noise filter (contact your DSL service provider) to the telephone line between the base unit and the telephone line jack.
The handset and/or base unit does not ring.	<ul style="list-style-type: none">• The ringer volume is turned off. Set to high, medium, or low (p. 17, 18).
The handset display is blank.	<ul style="list-style-type: none">• If the handset display is blank, fully charge the battery (p. 10).
You cannot program any function items.	<ul style="list-style-type: none">• Programming is not possible while the handset and/or base unit is being used.• Do not pause for over 60 seconds while programming.• Walk closer to the base unit.• While another user is listening to messages or the Answering System is handling a call, you cannot program. Try again later.
While programming or searching, the handset starts to ring and the program/search stops.	<ul style="list-style-type: none">• A call is coming in. To answer the call, press [↶], [📞] or [SP-PHONE]. Start again from the beginning after hanging up.

Troubleshooting

Problem	Cause & Remedy
You cannot make an intercom/ outside call.	<ul style="list-style-type: none">• Your handset is in remote operation mode (p. 64). Exit by pressing [OFF].• The handset you called is too far from the base unit.• If the handset or base unit is in use, you may not be able to make a call. Try again later.• If you are entering a phone number, or the handset enters the Caller List, phone book, redial list or one-touch dialer while the Talking Keypad or Announcement is turned on, you will not be able to make an outside call. To make an outside call, return to the standby mode.
You cannot redial.	<ul style="list-style-type: none">• If the last number dialed was more than 48 digits long, the number will not be redialed correctly.
You cannot make long distance calls.	<ul style="list-style-type: none">• Please make sure you have long distance service.
The handset does not display the caller's name and/or phone number.	<ul style="list-style-type: none">• You need to subscribe to Caller ID.• Other telephone equipment may be interfering with your phone. Disconnect it and try again.• Other electrical appliances connected to the same outlet may be interfering with Caller ID.• Telephone line noise may be affecting Caller ID.• The caller requested not to send his/her Caller ID information (p. 35).• If a call is being transferred to you, the Caller ID information will not be displayed.• If a (separate) Caller ID box is connected between the unit and the telephone wall jack, disconnect the Caller ID box or plug the unit directly into the wall jack.• If the unit is connected to a telephone line with DSL service, the unit may not display caller's name and/or phone number properly. We recommend connecting a noise filter (contact your DSL service provider) to the telephone line between the base unit and the telephone line jack.

Problem	Cause & Remedy
The handset and/or base unit does not announce the displayed caller's name.	<ul style="list-style-type: none"> • The handset and/or base unit ringer volumes are turned off. Set to high, medium, or low (p. 17, 18). • The Talking Caller ID feature is turned off. Turn it on (p. 36, 37).
The handset and/or base unit does not announce the displayed caller's name properly.	<ul style="list-style-type: none"> • Name pronunciation may vary. Name pronunciation quality is based on names most commonly used in the United States. • The handset and/or base unit will announce each letter of abbreviations, such as "Co." and "Inc." • Caller ID supports names of up to 15 letters. If the caller's name has more than 15 letters, the name will not be announced correctly.
The handset cannot automatically edit the Caller List/incoming phone numbers.	<ul style="list-style-type: none"> • The Caller ID number auto edit feature is turned off. Turn it on (p. 41) and try again. • You need to press [↩] or [⏪] after editing the number.
The handset display exits the Caller List or phone book.	<ul style="list-style-type: none"> • Do not pause for over 60 seconds while searching.
The Ringer/Message Alert indicator flashes slowly when the handset is not ringing and in use.	<ul style="list-style-type: none"> • The Message Alert is turned on and new messages have been recorded. Turn the Message Alert off (p. 28) or listen to the new messages (p. 63, 64, 67).
You cannot have a conversation using the headset.	<ul style="list-style-type: none"> • Make sure the optional headset is connected properly (p. 73). • If "SP-phone" is displayed on the handset, press [↩] to switch to the headset.
The handset does not announce the name and phone number in the caller list, phone book, redial list or one-touch dialer.	<ul style="list-style-type: none"> • Name Announcement is turned off. Turn it on (p. 22).
When Talking Keypad is turned on, the phone number you dialed is not announced correctly.	<ul style="list-style-type: none"> • If you dial a phone number quickly, the handset and base unit may not announce the dialed phone number correctly. For best results, dial each digit one at a time, and wait for the unit to announce each digit before dialing the next digit.

Troubleshooting

Problem	Cause & Remedy
The handset does not announce the entered number when pre-dialing (p. 30).	<ul style="list-style-type: none">• Handset Talking Keypad is turned off. Turn it on (p. 20).
The base unit does not announce the dialed number.	<ul style="list-style-type: none">• Base Unit Talking Keypad is turned off. Turn it on (p. 21).
When Talking Keypad and/or Name Announcement is turned on, the handset and/or base unit does not make announcements.	<ul style="list-style-type: none">• The Answering System is in use, such as answering a call or playing back messages. Try again later.• The handset has lost communication with the base unit. Walk closer to the base unit and try again.• The base unit is making an outside call.
When Name Announcement is turned on, the handset does not announce names properly.	<ul style="list-style-type: none">• If the name has more than 10 syllables, it will not be announced correctly. Maximum syllables that can be announced is 10. One digit of the number is counted as one syllable.• If the name has been abbreviated or an acronym is used, it may not be announced correctly. We recommend inserting a space between each letter (p. 45).
While the handset is announcing name or phone numbers, static, sound cuts in/out or fades occur.	<ul style="list-style-type: none">• Announcement is transmitted between the base unit and handset using wireless radio waves. Move the handset and base unit away from other electrical appliances to prevent interference (p. 3).
The talk time on the handset has been shortened.	<ul style="list-style-type: none">• Fully charge the battery (p. 10).• The battery may need to be replaced. If you install a new battery, fully charge it (p. 10).• The Hearing Aid mode is selected to "Telecoil". Turn it off (p. 23) and try again.

Answering System

Problem	Cause & Remedy
<p>The Answering System is on, but incoming messages are not recorded.</p>	<ul style="list-style-type: none"> • The recording time is set to “Greeting only”. Select “1 minute”, “2 minutes” or “3 minutes” (p. 26). • Memory is full. Erase unnecessary messages (p. 66).
<p>“ FULL ” flashes and the ANSWER ON indicator flashes rapidly. No new messages are recorded.</p>	<ul style="list-style-type: none"> • Memory is full. Erase unnecessary messages (p. 66).
<p>You cannot operate the Answering System from the base unit or the handset.</p>	<ul style="list-style-type: none"> • If another user is in use, you may not be able to operate the Answering System. Try again later. • If another user is listening to messages or the Answering System is handling a call, you cannot operate the Answering System. Try again later. • When the unit is announcing a list item (name or phone number) or a dialed number, you cannot operate the Answering System. Try again later.
<p>You cannot operate the Answering System from a touch tone phone.</p>	<ul style="list-style-type: none"> • Make sure you entered the correct remote code (p. 68). • The Answering System may not respond if the tones are too short to activate the unit. Press each button firmly. • The Answering System is off. Turn it on (p. 70).
<p>You cannot erase messages.</p>	<ul style="list-style-type: none"> • While another user is operating the Answering System or a caller is leaving a message, you cannot erase messages.
<p>When you play back messages or turn on the Answering System, the handset and base unit announce the wrong day and time.</p>	<ul style="list-style-type: none"> • The date and time may be set incorrectly. Set the date and time again (p. 14).

Troubleshooting

General

Problem	Cause & Remedy
The unit does not work.	<ul style="list-style-type: none">• Check the settings (p. 9–11).• Check whether the dialing mode setting is correct (p. 15).• Fully charge the battery (p. 10).• Clean the charge contacts and charge again (p. 11).• Check battery installation (p. 10).• Unplug the base unit's AC adaptor to reset it. Plug in, and try again.• Re-install the battery (p. 10) and fully charge it.
"Recharge battery" is displayed, "■" flashes, or the handset beeps intermittently.	<ul style="list-style-type: none">• Fully charge the battery (p. 10).
"Charge for 6h" and "■" are displayed and the handset does not work.	<ul style="list-style-type: none">• The battery has been discharged. Fully charge the battery (p. 10).• Check battery installation (p. 10).
You charged the battery fully, but "Recharge battery" is still displayed and/or "■" continues to flash, or "Charge for 6h" and "■" are displayed.	<ul style="list-style-type: none">• Clean the charge contacts and charge again (p. 11).• The battery may need to be replaced. If you install a new battery, fully charge it (p. 10).
The CHARGE indicator does not go out after the battery has been charged.	<ul style="list-style-type: none">• This is normal.
If you cannot solve your problem	<ul style="list-style-type: none">• Visit our website: http://www.panasonic.com/support• Contact us via the web at: http://www.panasonic.com/contactinfo• Call our customer call center at: 1-800-211-PANA(7262)

Important Safety Instructions

When using this unit, basic safety precautions should always be followed to reduce the risk of fire, electric shock, or personal injury.

1. Read and understand all instructions.
2. Follow all warnings and instructions marked on this unit.
3. Unplug this unit from AC outlets before cleaning. Do not use liquid or aerosol cleaners. Use a damp cloth for cleaning.
4. Do not use this unit near water, for example, near a bathtub, washbowl, kitchen sink, or the like.
5. Place this unit securely on a stable surface. Serious damage and/or injury may result if the unit falls.
6. Do not cover slots and openings on the unit. They are provided for ventilation and protection against overheating. Never place the unit near radiators, or in a place where proper ventilation is not provided.
7. Use only the power source marked on the unit. If you are not sure of the type of power supplied to your home, consult your dealer or local power company.
8. Do not place objects on the power cord. Install the unit where no one can step or trip on the cord.
9. Do not overload wall outlets and extension cords. This can result in the risk of fire or electric shock.
10. Never push any objects through slots in this unit. This may result in the risk of fire or electric shock. Never spill any liquid on the unit.
11. To reduce the risk of electric shock, do not disassemble this unit. Take the unit to an authorized servicenter when service is required. Opening or removing covers may expose you to dangerous voltages or other risks. Incorrect reassembly can cause electric shock when the unit is subsequently used.
12. Unplug this unit from the wall outlet and refer servicing to an authorized servicenter when the following conditions occur:
 - A. When the power supply cord or plug is damaged or frayed.
 - B. If liquid has been spilled into the unit.
 - C. If the unit has been exposed to rain or water.
 - D. If the unit does not work normally by following the operating instructions. Adjust only controls covered by the operating instructions. Improper adjustment may require extensive work by an authorized servicenter.
 - E. If the unit has been dropped or physically damaged.
 - F. If the unit exhibits a distinct change in performance.
13. During thunderstorms, avoid using telephones except cordless types. There may be a remote risk of an electric shock from lightning.
14. Do not use this unit to report a gas leak, when in the vicinity of the leak.

SAVE THESE INSTRUCTIONS

Important Safety Instructions

CAUTION:

To reduce the risk of fire or injury to persons, read and follow these instructions.

1. Use only the battery(ies) specified.
2. Do not dispose of the battery(ies) in a fire. They may explode. Check with local waste management codes for special disposal instructions.
3. Do not open or mutilate the battery(ies). Released electrolyte is corrosive and may cause burns or injury to the eyes or skin. The electrolyte may be toxic if swallowed.
4. Exercise care in handling batteries in order not to short the battery to conductive materials such as rings, bracelets, and keys. The battery and/or conductor may overheat and cause burns.
5. Charge the battery(ies) provided with or identified for use with this product only in accordance with the instructions and limitations specified in this manual.

WARNING:

TO PREVENT FIRE OR SHOCK HAZARD, DO NOT EXPOSE THIS PRODUCT TO RAIN OR ANY TYPE OF MOISTURE.

- The AC adaptor is used as the main disconnect device, ensure that the AC outlet is located/installed near the unit and is easily accessible.

FCC and Other Information

This equipment complies with Part 68 of the FCC rules and the requirements adopted by the ACTA. On the bottom of this equipment is a label that contains, among other information, a product identifier in the format US:ACJ-----. If requested, this number must be provided to the telephone company.

Registration No. (found on the bottom of the unit)
Ringer Equivalence No. (REN)0.1B

A plug and jack used to connect this equipment to the premises wiring and telephone network must comply with the applicable FCC Part 68 rules and requirements adopted by the ACTA. A compliant telephone cord and modular plug is provided with this product. It is designed to be connected to a compatible modular jack that is also compliant.

The REN is used to determine the number of devices that may be connected to a telephone line. Excessive RENs on a telephone line may result in the devices not ringing in response to an incoming call. In most but not all areas, the sum of RENs should not exceed five (5.0). To be certain of the number of devices that may be connected to a line, as determined by the total RENs, contact the local telephone company. For products approved after July 23, 2001, the REN for this product is part of the product identifier that has the format US:AAAEQ##TXXXX. The digits represented by ## are the REN without a decimal point (e.g., 03 is a REN of 0.3).

If this equipment causes harm to the telephone network, the telephone company will notify you in advance that temporary discontinuance of service may be required. But if advance notice isn't practical, the telephone company will notify the customer as soon as possible. Also, you will be advised of your right to file a complaint with the FCC if you believe it is necessary.

FCC and Other Information

The telephone company may make changes in its facilities, equipment, operations or procedures that could affect the operation of the equipment. If this happens the telephone company will provide advance notice in order for you to make necessary modifications to maintain uninterrupted service.

If trouble is experienced with this equipment, for repair or warranty information, please contact a Factory Servicenter or other Authorized Servicer. If the equipment is causing harm to the telephone network, the telephone company may request that you disconnect the equipment until the problem is resolved.

Connection to party line service is subject to state tariffs. Contact the state public utility commission, public service commission or corporation commission for information.

If your home has specially wired alarm equipment connected to the telephone line, ensure the installation of this equipment does not disable your alarm equipment. If you have questions about what will disable alarm equipment, consult your telephone company or a qualified installer.

WHEN PROGRAMMING EMERGENCY NUMBERS AND(OR) MAKING TEST CALLS TO EMERGENCY NUMBERS:

- 1) Remain on the line and briefly explain to the dispatcher the reason for the call.
- 2) Perform such activities in the off-peak hours, such as early morning or late evenings.

This device complies with Part 15 of the FCC Rules. Operation is subject to the following two conditions: (1) This device may not cause harmful interference, and (2) this device must accept any interference received, including interference that may cause undesired operation.

Privacy of communications may not be ensured when using this phone.

CAUTION:

Any changes or modifications not expressly approved by the party responsible for compliance could void the user's authority to operate this device.

Note:

This equipment has been tested and found to comply with the limits for a Class B digital device, pursuant to Part 15 of the FCC Rules. These limits are designed to provide reasonable protection against harmful interference in a residential installation. This equipment generates, uses, and can radiate radio frequency energy and, if not installed and used in accordance with the instructions, may cause harmful interference to radio communications. However, there is no guarantee that interference will not occur in a particular installation. If this equipment does cause harmful interference to radio or television reception, which can be determined by turning the equipment off and on, the user is encouraged to try to correct the interference by one or more of the following measures:

- Reorient or relocate the receiving antenna.
- Increase the separation between the equipment and receiver.
- Connect the equipment into an outlet on a circuit different from that to which the receiver is connected.
- Consult the dealer or an experienced radio/TV technician for help.

Some cordless telephones operate at frequencies that may cause interference to nearby TVs and VCRs. To minimize or prevent such interference, the base of the cordless telephone should not be placed near or on top of a TV or VCR. If interference is experienced, move the cordless telephone further away from the TV or VCR. This will often reduce, or eliminate, interference.

FCC and Other Information

Operating near 2.4 GHz electrical appliances may cause interference. Move away from the electrical appliances.

FCC RF Exposure Warning:

This product complies with FCC radiation exposure limits set forth for an uncontrolled environment.

To comply with FCC RF exposure requirements the base unit must be installed and operated with its antenna located 20 cm or more between antenna and all person's body (excluding extremities of hands, wrist and feet). The handset unit may be carried and operated with only the specific provided belt-clip. Other non-tested belt-clips or similar body-worn accessories may not comply and must be avoided. The base and handset units must not be co-located or operated in conjunction with any other antenna or transmitter.

This equipment is hearing aid compatible as defined by the FCC in 47 CFR Section 68.316.

When you hold the phone to your ear, noise might be heard in your Hearing Aid. Some Hearing Aids are not adequately shielded from external RF (radio frequency) energy. If noise occurs, turn the Hearing Aid mode to Telecoil. If noise is still heard, use an optional accessory headset or the speakerphone option (if applicable) when using this phone. Consult your audiologist or Hearing Aid manufacturer about the availability of Hearing Aids which provide adequate shielding to RF energy commonly emitted by digital devices.

- **Environment** — do not place the unit in a room where the temperature is less than 5°C (41°F) or greater than 40°C (104°F). Allow 10 cm (4") clearance around the unit for proper ventilation. Avoid excessive smoke, dust, mechanical vibration, shock, or direct sunlight.
- **Medical** — consult the manufacturer of any personal medical devices, such as pacemakers or hearing aids, to determine if they are adequately shielded from external RF (radio frequency) energy. (The unit operates in the frequency range of 2400 MHz to 2481 MHz, and the power output level can range from 0.04 watts to 0.1 watts.) Do not use the unit in health care facilities if any regulations posted in the area instruct you not to do so. Hospitals or health care facilities may be using equipment that could be sensitive to external RF (radio frequency) energy.
- **Routine care** — wipe the unit with a soft cloth. Do not use benzine, thinner, or any abrasive powder. When you leave the unit unused for a long period of time, unplug the AC adaptor from the outlet.
- **If there is any trouble** — disconnect the unit from the telephone line and connect a known working phone. If the known working phone operates properly, have your unit repaired by one of the authorized Panasonic Factory Service Centers. If the known working phone does not operate properly, consult your telephone company.

Index

- A**
- Accessories 2
 - Answering calls, base unit 34
 - Answering calls, handset 34
 - Answering System 61
 - Auto talk 16, 34
- B**
- Backlit LCD 32
 - Base unit location 3
 - Battery charge 3, 10
 - Battery information* 11
 - Battery replacement 11
 - Battery strength 10
 - Belt clip 72
- C**
- Call monitoring* 62
 - Call share 56
 - Call Waiting Caller ID display 57
 - Call waiting tone 57
 - Caller ID number auto edit* 41
 - Caller ID service 14, 35
 - Caller List, editing 40
 - Caller List, erasing 43
 - Caller List, storing 42
 - Caller List, viewing 38
 - Calling back from the Caller List 39
 - Chain dial* 48
 - Conf (Conference) 56
 - Conference calls 56
- D**
- Date and time* 14
 - Dialing mode 15
 - Direct commands 74, 75
 - Display language 15
- E**
- Erasing a message 66, 70
 - Erasing all messages 66, 70
 - Error messages 76
- F**
- FCC and other information 84
 - FLASH button 58
 - Flash time 58
- Function menu,*
 - Direct commands* 74
 - Function menu, selection 12
 - Function menu, table 13
- G**
- Greeting message* 23
- H**
- Headset, optional 73
 - Hearing Aid 23
 - Hold 31, 33
- I**
- Incoming call tone 59
 - Installation, AC adaptor 9
 - Installation, battery 10
 - Installation, telephone line cord 9
 - Intercom call 52
- K**
- Key tone 60
- L**
- LCD contrast 20
 - Lighted handset keypad 32
 - Line mode 16
 - Listening to messages 63, 64, 67
 - Location of controls 6, 7
 - Locator 53
- M**
- Making calls, base unit 32
 - Making calls, handset 29, 30
 - Memo message 67
 - Message alert* 28
 - Message storage 25
 - Microphone, base unit 24, 32
 - Microphone, handset 29
 - Monitoring incoming calls* 62
 - Mute 57
- N**
- Name Announcement 22
 - Navigator key 8
 - Noise 3
 - Number of rings 26

Index

O

- One-Touch Dialer* 50
- One-Touch Dialer, dialing 51
- One-Touch Dialer, erasing 52
- One-Touch Dialer, storing 50

P

- PAUSE 58
- Phone book* 44
- Phone book, dialing 46
- Phone book, editing 49
- Phone book, erasing 49
- Phone book, names 45
- Phone book, storing 44
- Power failure 9, 14, 25
- Pre-dial 30
- Pulse service 57

R

- Recording mode* 27
- Recording time 26
- Redial 30, 33
- Redial list 31
- Registration* 60
- Remote code 68
- Remote operation, handset 64
- Remote operation,
touch tone phone 67
- Ringer off 17, 18, 34
- Ringer tone 18, 19
- Ringer volume 17, 18
- Rotary service, tone dialing 57

S

- Safety instructions 83
- Shipping product
for service Back Cover
- Shoulder rest attachment 72
- Slow Talk message playback . 65, 70
- Soft keys 7
- Specifications 91
- SP-phone, base unit 32
- SP-phone, handset 29

T

- Talking Caller ID* 36
- Talking Keypad, base unit 21
- Talking Keypad, handset 20
- Toll saver 27
- Transferring a call* 54
- Troubleshooting,
Answering System 81
- Troubleshooting, general 82
- Troubleshooting,
Telephone System 77
- TTY 2, 90, Back Cover

V

- VE (Voice Enhancer) 32
- Voice enhancer technology* 32
- Voice menu 64, 69
- Volume control, base unit 33, 65
- Volume control, handset 30, 65

W

- Wall mounting 71
- Warranty 89

• “—” indicates important information and frequently used features.

PANASONIC CONSUMER
ELECTRONICS COMPANY, DIVISION
OF PANASONIC CORPORATION OF
NORTH AMERICA

One Panasonic Way,
Secaucus, New Jersey 07094

PANASONIC PUERTO RICO, INC.
San Gabriel Industrial Park,
Ave. 65 de Infantería, Km. 9.5,
Carolina, Puerto Rico 00985

Panasonic Telephone Products Limited Warranty

Limited Warranty Coverage

If your product does not work properly because of a defect in materials or workmanship, Panasonic Consumer Electronics Company or Panasonic Puerto Rico, Inc. (collectively referred to as "the warrantor") will, for the length of the period indicated on the chart below, which starts with the date of original purchase ("Limited Warranty period"), at its option either (a) repair your product with new or refurbished parts, or (b) replace it with a new or a refurbished product. The decision to repair or replace will be made by the warrantor.

Parts
One (1) Year

Labor
One (1) Year

During the "Labor" Limited Warranty period there will be no charge for labor. During the "Parts" Limited Warranty period, there will be no charge for parts. You must mail-in your product during the Limited Warranty period. This Limited Warranty excludes both parts and labor for batteries, antennas, and cosmetic parts (cabinet). This Limited Warranty only applies to products purchased and serviced in the United States or Puerto Rico. This Limited Warranty is extended only to the original purchaser and only covers products purchased as new.

Mail-In Service

For assistance in the continental U.S.A. in obtaining repairs please ship the product to:

Panasonic Services Company Customer Servicer
4900 George McVay Drive Suite B Door #12 McAllen, TX 78503

For assistance in Puerto Rico call Panasonic Puerto Rico, Inc. (787)-750-4300 or fax (787)-768-2910.

For Limited Warranty service for headsets if a headset is included with this product please call Panasonic Call Center at 1-800-211-PANA (7262).

When shipping the unit carefully pack, include all accessories, and send it prepaid, adequately insured and preferably in the original carton. Include a letter detailing the complaint and provide a day time phone number where you can be reached.

IF REPAIR IS NEEDED DURING THE LIMITED WARRANTY PERIOD THE PURCHASER WILL BE REQUIRED TO FURNISH A SALES RECEIPT/PROOF OF PURCHASE INDICATING DATE OF PURCHASE, AMOUNT PAID AND PLACE OF PURCHASE. CUSTOMER WILL BE CHARGED FOR THE REPAIR OF ANY UNIT RECEIVED WITHOUT SUCH PROOF OF PURCHASE.

Limited Warranty Limits And Exclusions

This Limited Warranty ONLY COVERS failures due to defects in materials or workmanship, and DOES NOT COVER normal wear and tear or cosmetic damage. The Limited Warranty ALSO DOES NOT COVER damages which occurred in shipment, or failures which are caused by products not supplied by the warrantor, or failures which result from accidents, misuse, abuse, neglect, mishandling, misapplication, alteration, faulty installation, set-up adjustments, misadjustment of consumer controls, improper maintenance, power line surge, lightning damage, modification, introduction of sand, humidity or liquids, commercial use such as hotel, office, restaurant, or other business or rental use of the product, or service by anyone other than a Factory Servicer or other Authorized Servicer, or damage that is attributable to acts of God.

THERE ARE NO EXPRESS WARRANTIES EXCEPT AS LISTED UNDER "LIMITED WARRANTY COVERAGE". THE WARRANTOR IS NOT LIABLE FOR INCIDENTAL OR CONSEQUENTIAL DAMAGES RESULTING FROM THE USE OF THIS PRODUCT, OR ARISING OUT OF ANY BREACH OF THIS LIMITED WARRANTY. (As examples, this excludes damages for lost time, lost calls or messages, cost of having someone remove or re-install an installed unit if applicable, travel to and from the servicer. The items listed are not exclusive, but are for illustration only.) **ALL EXPRESS AND IMPLIED WARRANTIES, INCLUDING THE WARRANTY OF MERCHANTABILITY, ARE LIMITED TO THE PERIOD OF THE LIMITED WARRANTY.**

Some states do not allow the exclusion or limitation of incidental or consequential damages, or limitations on how long an implied warranty lasts, so the exclusions may not apply to you. This Limited Warranty gives you specific legal rights and you may also have other rights which vary from state to state. If a problem with this product develops during or after the Limited Warranty period, you may contact your dealer or Servicenter. If the problem is not handled to your satisfaction, then write to the warrantor's Consumer Affairs Department at the addresses listed for the warrantor.

PARTS AND SERVICE, WHICH ARE NOT COVERED BY THIS LIMITED WARRANTY, ARE YOUR RESPONSIBILITY.

Customer Services Directory

Obtain Product Information and Operating Assistance; locate your nearest Dealer or Servicenter; purchase Parts and Accessories; or make Customer Service and Literature requests by visiting our Web Site at:

<http://www.panasonic.com/consumersupport>

or, contact us via the web at:

<http://www.panasonic.com/contactinfo>

You may also contact us directly at: 1-800-211-PANA (7262),
Monday-Friday 9 am-9 pm; Saturday-Sunday 10 am-7 pm, EST.

For hearing or speech impaired TTY users, TTY : 1-877-833-8855

Accessory Purchases

Purchase Parts, Accessories and Instruction Books online for all Panasonic Products by visiting our Web Site at:

<http://www.pasc.panasonic.com>

or, send your request by E-mail to:

npcparts@us.panasonic.com

You may also contact us directly at:
1-800-332-5368 (Phone) 1-800-237-9080 (Fax Only)
(Monday - Friday 9 am to 8 pm, EST.)

Panasonic Services Company
20421 84th Avenue South, Kent, WA 98032
(We Accept Visa, MasterCard, Discover Card, American Express,
and Personal Checks)

For hearing or speech impaired TTY users, TTY : 1-866-605-1277

Service in Puerto Rico

***Panasonic Puerto Rico, Inc.
San Gabriel Industrial Park, Ave. 65 de Infantería, Km. 9.5,
Carolina, Puerto Rico 00985
Phone (787)750-4300, Fax (787)768-2910***

Specifications

■ Base Unit

- Power Supply:** AC Adaptor (120 V AC, 60 Hz)
- Power Consumption:** Standby: Approx. 2.0 W
Maximum: Approx. 5.4 W
- Frequency:** 2.4 GHz – 2.48 GHz
- Dimensions (H x W x D):** Approx. 85 mm x 175 mm x 200 mm
(3 11/32" x 6 7/8" x 7 7/8")
- Mass (Weight):** Approx. 470 g (1.04 lb.)

■ Handset

- Power Supply:** Ni-MH battery (3.6 V, 830 mAh)
- Frequency:** 2.4 GHz – 2.48 GHz
- Dimensions (H x W x D):** Approx. 208 mm x 52 mm x 39 mm
(8 3/16" x 2 1/16" x 1 17/32")
- Mass (Weight):** Approx. 190 g (0.42 lb.)
- Security Codes:** 1,000,000

- Dialing Mode:** Tone (DTMF)/Pulse

- Operating Environment:** 5 °C – 40 °C (41 °F – 104 °F)

Specifications are subject to change without notice.

Energy Star:

As an ENERGY STAR® Participant, Panasonic has determined that this product meets the ENERGY STAR guidelines for energy efficiency. ENERGY STAR is a U.S. registered mark.



For your future reference

Serial No. _____ Date of purchase _____

(found on the bottom of the unit)

Name and address of dealer _____

For product service

- Visit our website: <http://www.panasonic.com/support>
- Contact us via the web at: <http://www.panasonic.com/contactinfo>
- Call us at: 1-800-211-PANA(7262)

When you ship the product

- Carefully pack your unit, preferably in the original carton.
- Attach a letter, detailing the symptom, to the outside of the carton.

Symptom

- Send the unit to an authorized servicer, prepaid and adequately insured.
- Do not send your unit to the Panasonic Consumer Electronics Company listed below or to executive or regional sales offices. These locations do not repair consumer products.

- This cordless telephone is designed for use in the United States of America. Sale or use of this product in other countries may violate local laws.
- Ce téléphone sans fil est conçu pour être utilisé aux États-Unis d'Amérique. La vente ou l'emploi de cet appareil dans certains autres pays peut constituer une infraction à la législation locale.
- Este teléfono inalámbrico fue elaborado para uso en los Estados Unidos de América. La venta o el empleo de este producto en ciertos países puede constituir violación de la legislación local.
- このコードレス電話機は、日本国外での使用を目的として設計されており、日本国内での使用は法律違反となります。従って、当社では日本国内においては原則として修理などのサービスは致しかねます。

**If you need assistance with the setup or operation,
please call 1-800-211-PANA(7262)**

For hearing or speech impaired TTY users, TTY : 1-877-833-8855

**Panasonic Consumer Electronics Company,
Division of Panasonic Corporation of North America**
One Panasonic Way, Secaucus, New Jersey 07094

Panasonic Puerto Rico, Inc.
San Gabriel Industrial Park, Ave. 65 de Infantería, Km. 9.5,
Carolina, Puerto Rico 00985